

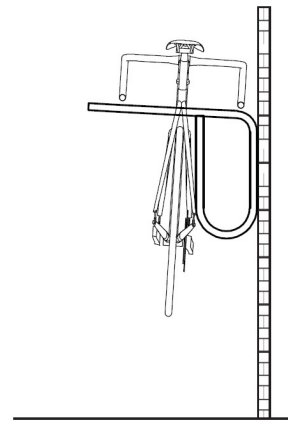

Installation Guide

EziHorizo Square Bike Rack

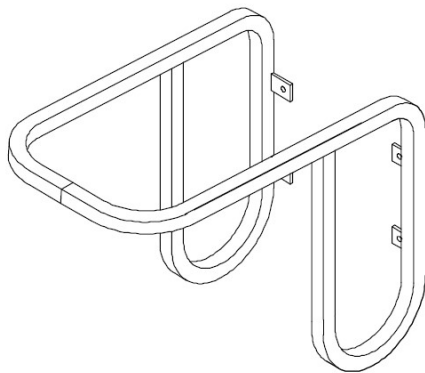

Site Selection

Suitable locations include;

- Above vehicle bonnet with appropriate clearance

Access and Clearance

Racks should be mounted at a height appropriate for a specific vehicle if clearance above the vehicle bonnet is required. Measures shown are an example only.

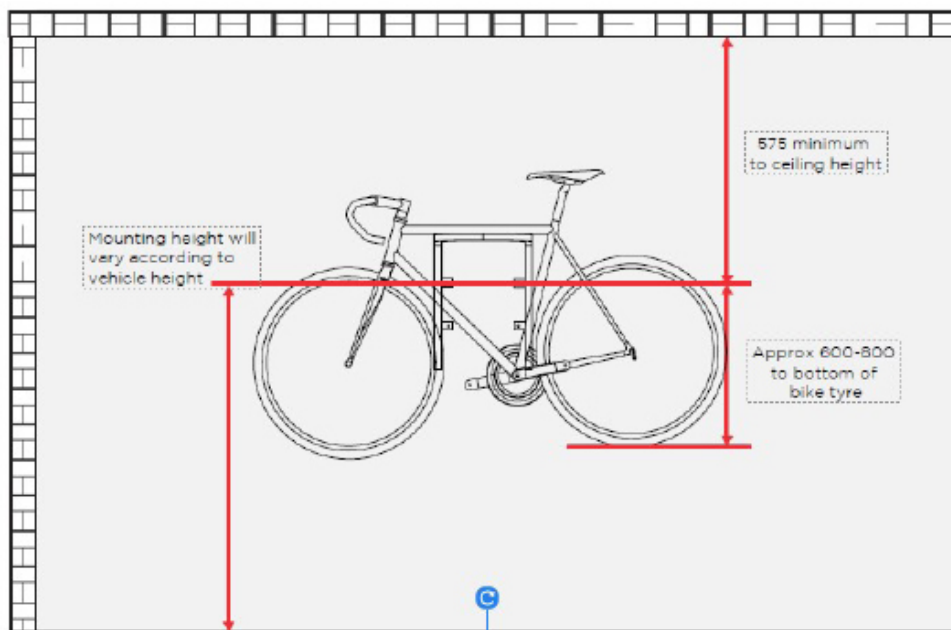



Installation Guide

EziHorizo Square Bike Rack

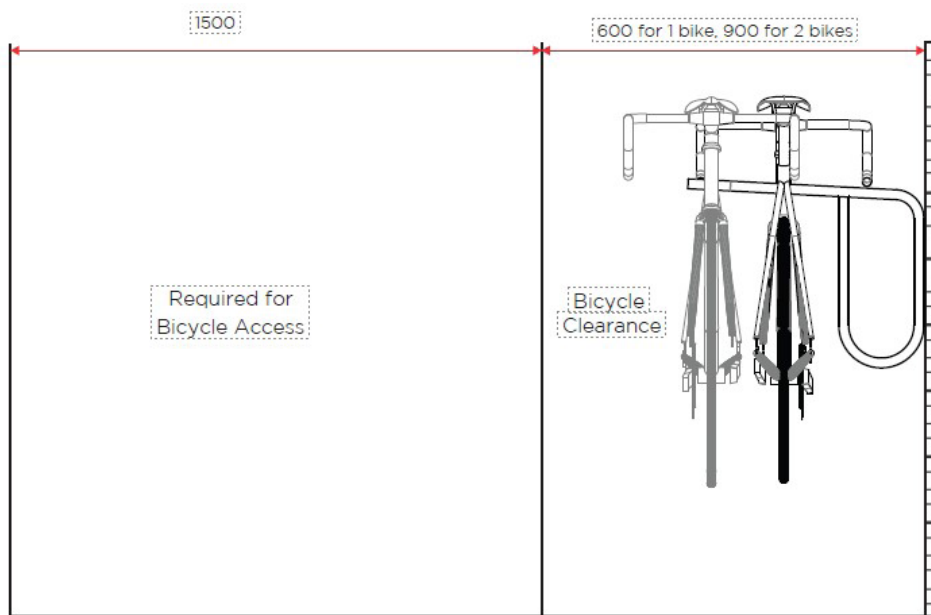

Locate and Measure

- Locate suitable area for rack installation with correct clearance on all sides.
- Draw a horizontal line to mark height of higher fixing point.

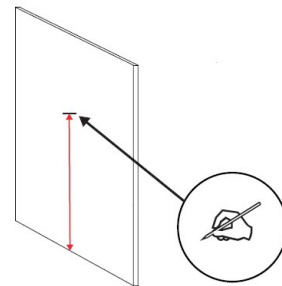

Mark and Drill

- Place rack in desired position and mark all fixing points with a suitable marker.
- Drill holes using a 8mm masonry drill bit to a depth of 70mm. For best results use a 6mm bit first to prevent wandering of the larger bit. Clear holes of dust.

Do not drill over plumbing and/or electrical conduits.

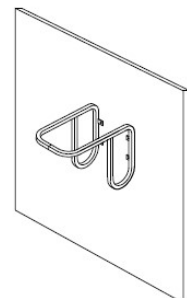



classic
architectural group

For Every Step®

Installation Guide

EziHorizo Square Bike Rack

Fix

Place rack in position and partially tighten screws starting from the top position. Once all screws are in, continue to tighten until firm. Use the 4 screw bolts (M8 x 60mm) provided plus a 13mm socket and driver to secure the racks.

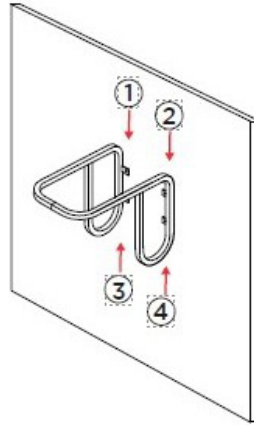

Installation Complete

