

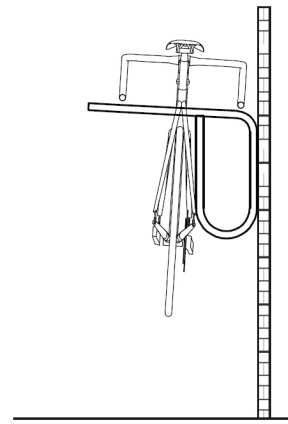

Installation Guide

Bicycle Rack - Wall Horizontal

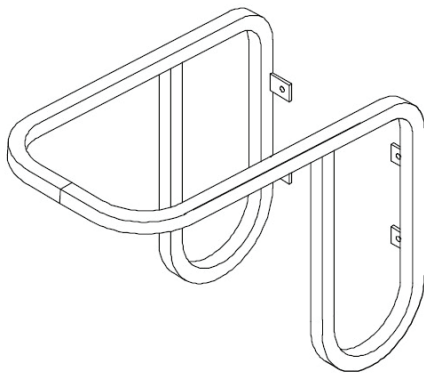

Site Selection

Suitable locations include;

- Above vehicle bonnet with appropriate clearance
- Adjacent to entrance doors and in line of sight of a window

Access and Clearance

Racks should be mounted at a height appropriate for a specific vehicle if clearance above the vehicle bonnet is required. Measures shown are an example only.

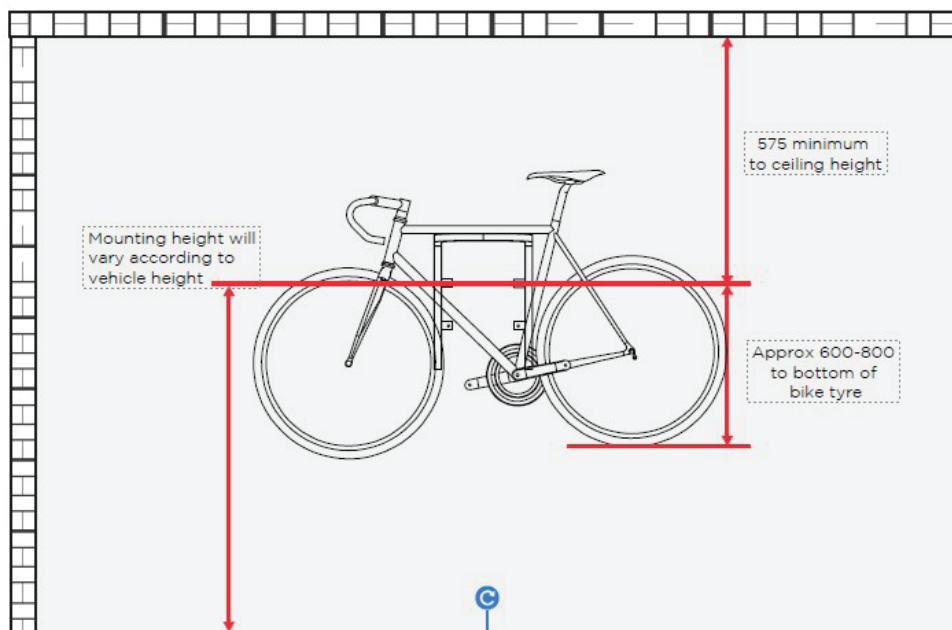



Installation Guide

Bicycle Rack - Wall Horizontal

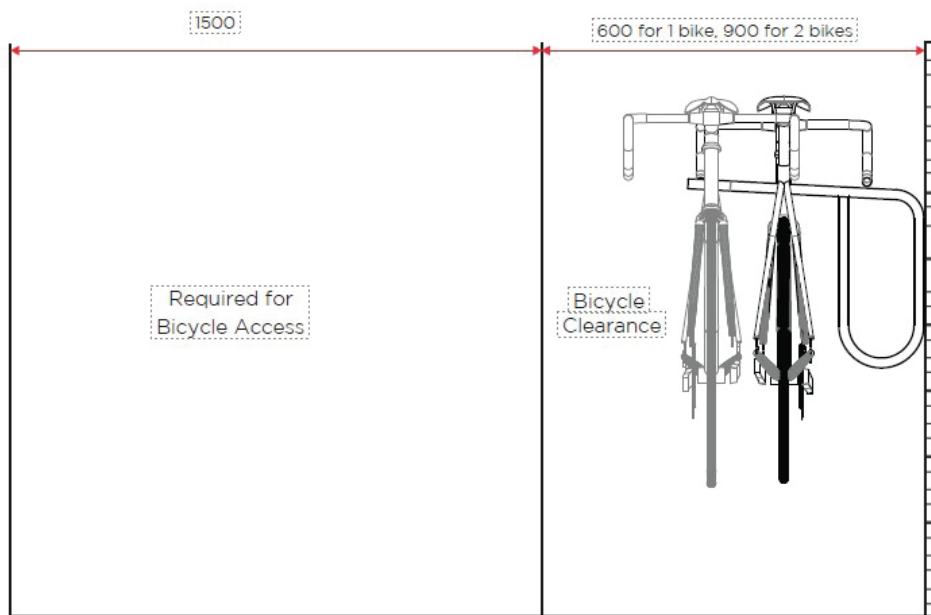

Locate and Measure

- Locate suitable area for rack installation with correct clearance on all sides.
- Draw a horizontal line to mark height of higher fixing point.

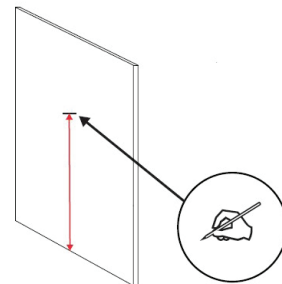

Mark and Drill

- Place rack in desired position and mark all fixing points with a suitable marker.
- Drill holes using a 8mm masonry drill bit to a depth of 70mm. For best results use a 6mm bit first to prevent wandering of the larger bit. Clear holes of dust.

Do not drill over plumbing and/or electrical conduits.

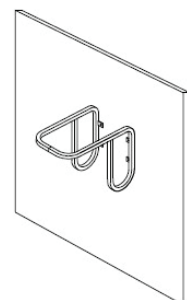



classic
architectural group

For Every Step®

Installation Guide

Bicycle Rack - Wall Horizontal

Fix

Place rack in position and partially tighten screws starting from the top position. Once all screws are in, continue to tighten until firm. Use the 4 screw bolts (M8 x 60mm) provided plus a 13mm socket and driver to secure the racks.

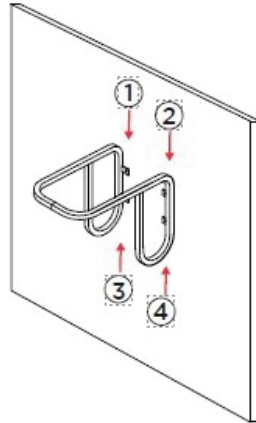

Installation Complete

