



classic
architectural group

For Every Step



Classic Tredfx

DKR135

Aluminium Safety Stair Nosing for Surface Mount Applications

Popular, proven and endorsed, the Tredfx range continues to expand and improve. Loved and used by thousands since its inception, this range has stood the test of time. Ideal for retro-fitting as well as fitting to new staircases, the Tredfx range remains superior in quality, affordable in cost and useful in application. Fit to interior and exterior stairs for increased safety and enhanced aesthetics.

Features

- Interior and exterior use
- Ramped back, long raked front
- Grit insert
- Pre-drilled and countersunk

Application

Surface mount

Supply Includes:

Cut to size. Drilled with fixings. CA290 adhesive and grit insert.

Length:

5850mm
(Cut-to-length service available)

Insert Colours



Aluminium Colours



Upon request

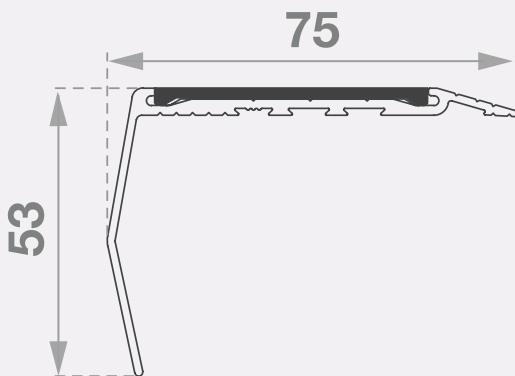

LRV (Light Reflectance Value) available



P5 Slip resistance rating



Fire test report available

**LIFETIME
WARRANTY**

**INSTALLATION
SERVICES
AVAILABLE**

