



**classic**  
architectural group

**product  
catalogue**

**edition 7**

architectural solutions





# contents



## Entrance Matting 12

Integra Verse	14	Integra Matting Tiles	34
Integra Vantt	18	Integra Coir	38
Integra Link	24	Integra Zoit	40
Integra Zone	26	Integra Shield	42
Integra Zeal	28	Integra Mat Frames	44
Integra Premier	30	Colour Guide	46
Integra Tough	32	LRV Values	55

## Stair Nosings 56

Solid Brass	58	Fibreglass	84
Surface Mount	62	Anti-Slip Tapes	86
Carpet / Vinyl / Rubber	70	Accessories	88
Rebated Timber / Tile	80	LRV Values	90

## Tactile Indicators 92

Solid Brass	94	Ceramic	110
Stainless Steel	98	Accessories	112
Aluminium	104	Colour Guide	114
Polyurethane	106	LRV Values	117

## Floor Trims & Covers 118

Expansion Joint Covers	118
Floor Trims	120

## Car Park Safety 126

Bollards	128	Corner Guards	148
Speed Humps	138	Convex Mirrors	152
Wheel Stops	142	Signage	154
Height Bars	146		

## Bike Racks & Skate Deterrents 158

Bike Racks	160
Skate Deterrents	164

## Reference Guides 169

Application Guides	170
Installation Guides	172
Care Guides	188



**We create better shared spaces  
Everyone deserves easy access**

Classic Architectural Group is trusted by building professionals across Australia because we have consistently listened to our customers, regulators and partners for over 40 years to provide exceptional client service.

We've continuously expanded and innovated our range of superior quality, customisable entrance mats, stair nosings, tactile indicators, covers and trims, skate deterrents and carpark safety systems. We monitor architectural trends and offer our products in a variety of styles and colours to complement any design or layout.

We specialise in end-to-end fulfilment from consultation, design, manufacturing, supply and installation, to get you a step ahead.

**We're incredibly proud to be an 100% Australian owned business, with people and operations across Australia.**





## Why Choose Classic?

**Consultative Approach** We listen to you to understand exactly what you need done and provide expert advice.

**Comprehensive Access** Your one-stop for all things public access and safety – entrance matting, stair nosings, tactiles and more.

**Customised Solutions** Forget cookie-cutter approaches, we innovate precise solutions to optimise your project goals.

**End-to-End Fulfilment** Our expertise spans consultation, design, manufacturing, supply and installation.

**Unrivalled Knowledge Of Standards** Feel confident when it comes to safety compliance and final inspection.

**Lifetime Warranty** Our lifetime warranty and customer satisfaction guarantee assure your lasting peace of mind.

**Over 40 Years Experience** Working with architects and building professionals Australia-wide.

**People and Operations Across Australia** To provide the local support you need.

## Our Core Values

**Rigorous** We are relentless in our pursuit of transcendent, world-class quality, service and efficiencies.

**Respectful** We uphold equality and integrity for all our business partners and users of public space.

**Responsible** We stand by our obligations to clients, staff, the community and the environment.

**Resourceful** We deliver seamless experiences through innovative solutions, with can-do versatility.





## We do more than you think...

Where practicality meets striking design, Classic's range of public access and safety solutions is a building professional's dream.

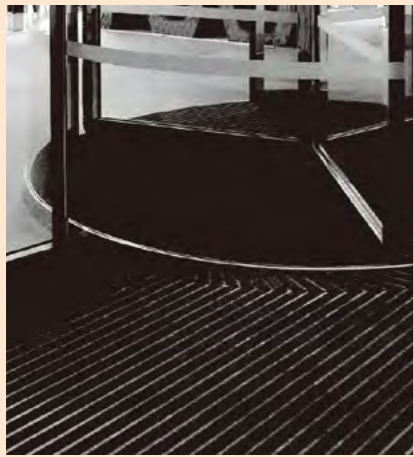

### Entrance Matting

Maintaining your building's presentation, longevity and a healthy environment, Classic's Integra Entrance Matting range creates cleaner, safer entrance areas. With customised options for both interior and exterior applications, our entrance mats keep up with your foot and wheeled traffic, effectively retaining dirt and moisture. Asset protection that aesthetically pleases, minimising your floor maintenance costs and reducing slip hazards.

Stopping the dirt, stopping the show, **it's our winning entry.**



### Stair Nosings

The professional finish to any access stair and ramp area, Classic's Tredfx Stair Nosings elevate smart looks and safety. With a wide range of anti-slip solutions for various substrates and environments, our stair nosings and tapes are rated for commercial grade use. Architecturally designed for your project, providing enhanced safety and accessibility for all.

Stepping up to every challenge, **we'll give you the extra grip.**



### Tactile Indicators

A must for all public access areas, Classic's Tredfx Tactile Indicators give directional guidance and alert of impending hazards. Empowering our visually-impaired community in shared spaces, we offer a diverse variety of styles and colours to meet your tactile floor safety requirements. From stainless steel and brass, to polyurethane and ceramic, our cutting-edge Tredfx Tactile range meets all NCC and relevant Australian Standards.

Navigating you with certainty, **you'll never lose your bearings with us.**



### Floor Trims & Covers

Classic's Tredfx Floor Trims, Expansion Joints and Covers are purposefully designed and engineered for commercial flooring applications. Overcoming small floor height discrepancies and covering joints between differing floor surfaces, our floor trims maximise safety while preserving aesthetics. Our heavy-duty expansion joint covers are built for protection and longevity, withstanding high-traffic areas.

Where two become one, **a seamless integration for all.**



### Car Park Safety

Classic's Car Park Safety range includes Wheel Stops, Bollards, Speed Humps, Corner Guards, Signage, Convex Mirrors and much more. Keeping pace with modern building design and techniques, we'll collaborate with you to enhance the protection of your car parking space and its users. From traffic flow to visual safety, we've got you sorted.

Driven to succeed, **we'll see you at the finish line.**

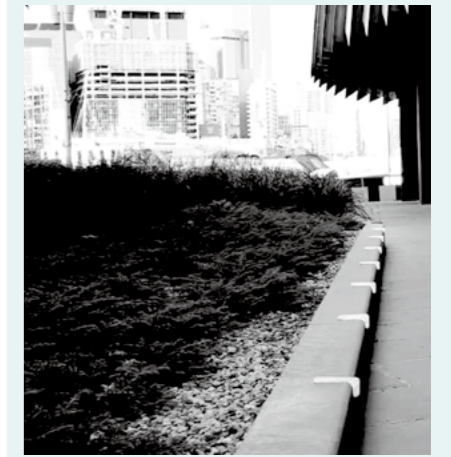

### Bike Racks & Skate Deterrents

Classic's Bike Racks provide cyclists with safe bicycle storage while encouraging communities to embrace more sustainable living. Classic's Skatestop Skate Deterrents protect your landscape's presentation and longevity, offering safety, durability and aesthetics. Our skate deterrents work hard to save you time and money on damage costs caused by skateboarders, in-line skates and bikes. It's smart, simple prevention.

We'll get rolling on your projects **quick smart.**



## Everyone deserves easy access...

That's why we specialise in the end-to-end solution.

**Consultation • Design • Manufacture • Supply • Installation**



### 1 Entrance Matting

Architecturally designed to ensure a sleek, modern aesthetic and hard wearing durability. Customised solutions for interior and exterior applications.

### 2 Stair Nosings

Safety's a given with a solution for all application types, including both interior and exterior options. Trend led designs include solid brass.

### 3 Tactile Indicators

Warning and directional tactile indicators to assist the visually impaired. Diverse range of product options and colours to satisfy safety requirements and enhance the aesthetic.

### 4 Floor Trims & Covers

Purposefully designed and engineered for commercial flooring applications. Customised solutions to maximise safety while maintaining visual appeal.

### 5 Car Park Safety

Solutions to enhance the protection of your car parking space and its users, including:

- a:** Bollards      **b:** Speed Humps      **c:** Wheel Stops
- d:** Height Bars    **e:** Corner Guards      **f:** Convex Mirrors

### 6 Bike Racks & Skate Deterrents

Designed to protect your landscape's presentation, our range is designed for safety, durability and aesthetics.

- a:** Bike Racks      **b:** Skate Deterrents

# ENTRANCE MATTING

## WHY CHOOSE CLASSIC?

- Consultative approach
- Customised solutions
- End-to-end fulfilment
- Unrivalled knowledge of standards
- Lifetime warranty
- Over 40 years' experience
- People and operations across Australia

Integra Verse

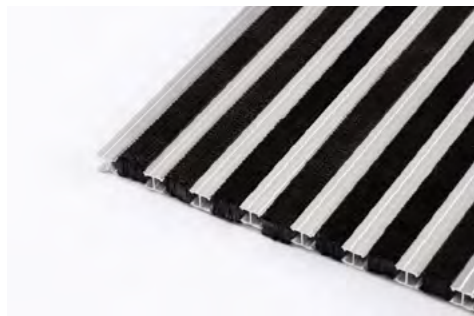

- Fully reversible aluminium matting
- Architecturally designed
- Durable and hard wearing
- Long lifetime design
- Optimum dirt and moisture retention
- Resistant to fungal and bacterial growth
- High traffic applications
- Interior and exterior use
- Suitable for wheelchairs and heavy trolleys

Integra Vantt



- Roll up aluminium matting
- Architecturally designed
- Suitable for curved applications
- Rubber cushioned back for reduced noise
- Flexible interlocking system
- Our most customisable product
- Wide colour range
- Medium to high traffic applications
- Interior use
- Wheelchair friendly

Integra Link



- Modular tiles with easy interlocking system
- Durable and hard wearing
- Highly effective and easy to clean
- Medium to high traffic applications
- Interior and exterior use
- Wheelchair friendly
- Easy to transport and install

Integra Zone



- Carpet style matting
- Special texturing and a thick, non-static cut-pile design
- Resistant to fungal and bacterial growth
- High fire resistant rating
- High water absorption
- Wide colour range
- High traffic applications
- Interior use
- Wheelchair friendly

Integra Zeal



- Carpet style matting
- Easy to clean and crush resistant
- Medium to high traffic applications
- Interior use
- Wheelchair friendly

Integra Premier



- Carpet style matting
- Ribbed chevron pattern design
- Releases trapped particles when vacuumed
- Medium to high traffic applications
- Interior use
- Wheelchair friendly

Integra Tough



- Unique pebble pattern for highly effective scraping
- Dense polypropylene pile provides excellent water and dirt retention
- Medium to high traffic applications
- Interior use
- Wheelchair friendly

Integra Matting Tiles



- Carpet style matting
- Modular system
- Ribbed and plush options
- Dense polypropylene pile forms effective moisture absorbing barrier
- Medium to high traffic applications
- Interior use
- Easy to transport and install

Integra Coir



- Natural coconut fibre matting
- Environmentally friendly
- Moisture absorbent
- Low traffic applications
- Interior use

Integra Zoit



- Carpet style matting
- Narrow, non-woven needlepunch carpet
- Ribbed design
- Resistant to fungal and bacterial growth
- High water absorption
- Low traffic applications
- Interior use

Integra Shield

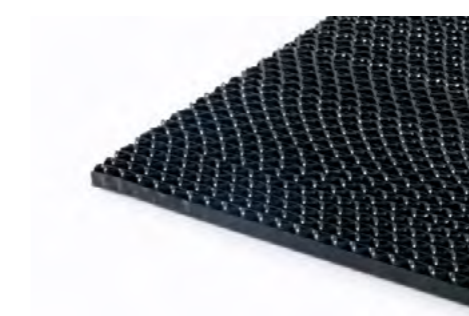

- Scraper entrance matting
- Durable and hard wearing
- Rolls up
- Resilient vinyl coiled construction, traps dirt
- UV resistant and withstands extreme temperatures
- High traffic applications
- Interior and exterior use, including snow and wet areas
- Wheelchair friendly

Integra Frames



- Entrance mat framing systems to suit all Classic Integra products
- Enhances entrance appearance
- Reduces custom fabrication cost and lead times
- Available in full lengths or cut to size
- Easy to transport and install

# Classic Integra Verse

## Reversible Aluminium Matting

- Fully reversible aluminium matting
- Architecturally designed
- Durable and hard wearing
- Long lifetime design
- Optimum dirt and moisture retention
- Resistant to fungal and bacterial growth
- High traffic applications
- Interior and exterior use
- Suitable for wheelchairs and heavy trolleys



## Classic Integra Verse R100

### Reversible Aluminium Matting

#### Description

Classic Integra Verse is one of the most robust entrance mats in the market. It is engineered to withstand the toughest and most demanding of environments. With unique features like double sided reversibility, Verse is a matting system that offers longevity like no other.

#### Application

Recess into mat wells, surface mount with ramp frame, wall-to-wall in airlocks and lobbies. High traffic areas. Interior and exterior use.

**Suitable for:** Commercial office buildings, shopping centres, hotels, motels, airports, schools and universities, hospitals and aged care homes, all public domains - libraries, etc.

#### Benefits

- Able to withstand ultra-high traffic
- Fully reversible, double sided construction allows longevity
- Regular turning keeps matting fresh
- Versatile design to allow best results

#### Specifications

##### Frames (see p44-45)

Suits the INFR11 framing system for 12mm and the INFR17 for 17mm

#### Matting Colours

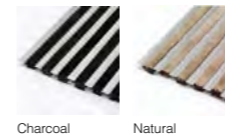

Charcoal

Natural

#### Aluminium Colours

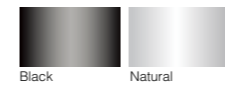

Black

Natural

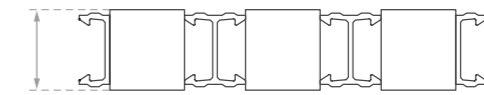

12mm & 17mm



Suitable for high traffic applications	Interior and exterior options available
Easy to clean. Highly effective scrape and wipe cleaning action	P5 Slip resistance rating
Resistant to fungal and bacterial growth	Fire test report available
Suitable for wheelchairs, heavy trolleys and other wheeled traffic	
Optimum dirt and moisture retention	
Healthier, cleaner environments	



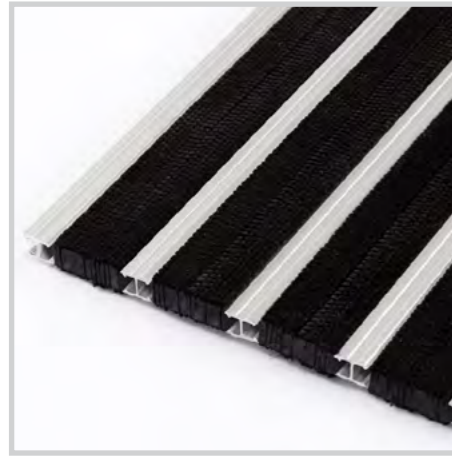

## Classic Integra Verse R200

### Reversible Aluminium Matting

#### Description

Classic Integra Verse is a stand-out in its field. It is engineered to withstand the toughest and most demanding of environments. With unique features like double sided reversibility, Verse is a matting system that offers longevity like no other. The R200 offers a greater wiper surface area which is therefore more suitable for applications where a larger amount of moisture absorption is required.

#### Application

Recess into mat wells, surface mount with ramp frame, wall-to-wall in airlocks and lobbies. High traffic areas. Interior and exterior use.

**Suitable for:** Commercial office buildings, shopping centres, hotels, motels, airports, schools and universities, hospitals and aged care homes, all public domains - libraries, etc.

#### Benefits

- Able to withstand ultra-high traffic
- Modular system to maximise wear
- Double wiper strips for optimum dirt and moisture retention
- Fully reversible, double sided construction allows longevity
- Regular turning keeps matting fresh
- Versatile design to generate best results

#### Specifications

##### Frames (see p44-45)

Suits the INFR11 framing system for 12mm and INFR17 for 17mm

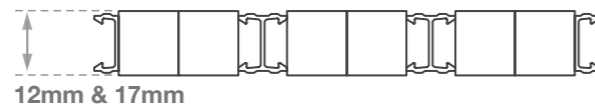

#### Matting Colours

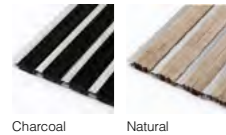

#### Aluminium Colours



**LIFETIME WARRANTY**

**INSTALLATION SERVICES AVAILABLE**

**NCC COMPLIANT**

**AS1428 COMPLIANT**

- Suitable for high traffic applications
- Easy to clean. Highly effective scrape and wipe cleaning action
- Resistant to fungal and bacterial growth
- Suitable for wheelchairs, heavy trolleys and other wheeled traffic
- Optimum dirt and moisture retention
- Healthier, cleaner environments
- Interior and exterior options available
- P5 Slip resistance rating
- Fire test report available



## Classic Integra Verse R300

### Reversible Aluminium Matting

#### Description

Classic Integra Verse is for someone who wants to stand out from the crowd. It is engineered to withstand the toughest and most demanding of environments. With unique features like double sided reversibility, Verse is a matting system that offers longevity like no other. The R300 presents the best of both worlds; more aluminium than R200 and more wiping area than the R100.

#### Application

Recess into mat wells, surface mount with ramp frame, wall-to-wall in airlocks and lobbies. High traffic areas. Interior and exterior use.

**Suitable for:** Commercial office buildings, shopping centres, hotels, motels, airports, schools and universities, hospitals and aged care homes, all public domains - libraries, etc.

#### Benefits

- Able to withstand ultra-high traffic
- Modular system to maximise wear
- Double wiper strips for optimum dirt and moisture retention
- Fully reversible, double sided construction allows longevity
- Regular turning keeps matting fresh
- Versatile design to generate best results

#### Specifications

##### Frames (see p44-45)

Suits the INFR11 framing system for 12mm and INFR17 for 17mm

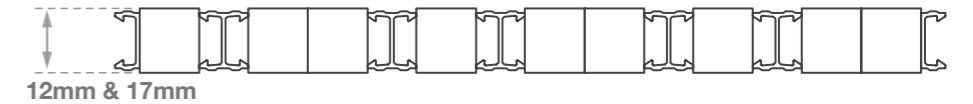

#### Matting Colours



#### Aluminium Colours



**LIFETIME WARRANTY**

**INSTALLATION SERVICES AVAILABLE**

**NCC COMPLIANT**

**AS1428 COMPLIANT**

- Suitable for high traffic applications
- Easy to clean. Highly effective scrape and wipe cleaning action
- Resistant to fungal and bacterial growth
- Suitable for wheelchairs, heavy trolleys and other wheeled traffic
- Optimum dirt and moisture retention
- Healthier, cleaner environments
- Interior and exterior options available
- P5 Slip resistance rating
- Fire test report available

# Classic Integra Vantt

## Roll-up Aluminium Matting

- Roll up aluminium matting
- Architecturally designed
- Suitable for curved applications
- Rubber cushioned back for reduced noise
- Flexible interlocking system
- Most customisable product
- Wide colour range
- Medium to high traffic applications
- Interior use
- Wheelchair friendly



## Classic Integra Vantt 2500 Roll-up Aluminium Matting

### Description

Classic Integra Vantt 2500 is the first of four options available in the Vantt range. The Vantt 2500 offers the unique features of the innovative flexible interlocking system, however it incorporates the Zoit micro-ribbed 'carpet type' matting for the budget conscious buyer.

### Application

Recess into mat wells, surface mount with ramp frame, wall-to-wall in airlocks and lobbies. Able to be cut into any shape or form providing the solution for architecturally shaped entrances and revolving doorways. Rated to suit medium traffic areas.

**Suitable for:** Small office buildings, small shopping centres, schools and factories.

### Benefits

- Reduces cleaning time of surrounding floor finishes
- Minimises costly slip-and-fall accidents
- Stops dirt at the door for a cleaner environment
- Enhances entrance appearance and acoustics

### Specifications

#### Frames (see p44-45)

Suits the INFR11 framing system

### Matting Colours

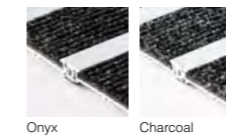

Onyx Charcoal

### Aluminium Colours



Natural

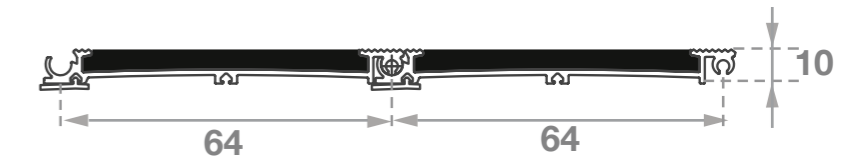

**10YR**  
WARRANTY

INSTALLATION  
SERVICES  
AVAILABLE

**AS1428**  
COMPLIANT

- Suitable for medium traffic applications
- Easy to clean. Highly effective scrape and wipe cleaning action
- Wheelchair friendly
- Rubber cushioned back for quietness underfoot
- Rolls up easily for cleaning
- Easily shaped for curved entrances or revolving doors
- Easy interlocking system

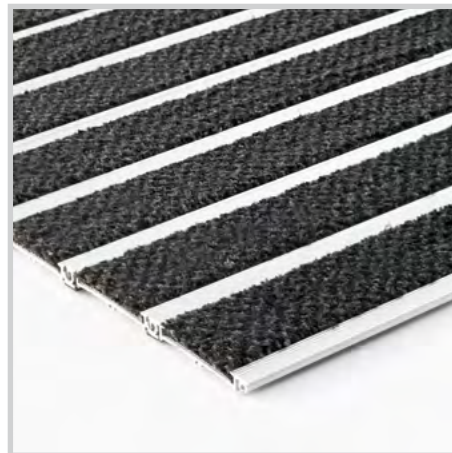

## Classic Integra Vantt 5500

### Roll-up Aluminium Matting

#### Description

Classic Integra Vantt 5500 is the original and market-proven Vantt entrance mat. The Vantt 5500 innovative flexible interlocking system features an alternating pattern of aluminium scraper bars incorporating the Zone non-static polyamide pile matting for optimum cleaning results. Install Vantt 5500 with the polymer scraper insert externally for slip resistance and removal of larger particles, and continue the mat through internally with the high quality polyamide matting insert for superior fine particle and moisture removal.

#### Application

Recess into mat wells, surface mount with ramp frame, wall-to-wall in airlocks and lobbies. Able to be cut into any shape or form providing the solution for architecturally shaped entrances and revolving doorways.

**Suitable for:** Commercial office buildings, shopping centres, hotels, motels, airports, schools and universities, hospital and aged care homes, all public domains - libraries, etc.

#### Benefits

- Colour range co-ordinates with the Integra Zone range of matting and enables a cohesive colour flow
- Reduces cleaning time of surrounding floor finishes
- Minimises costly slip-and-fall accidents
- Stops dirt at the door for a cleaner environment
- Enhances entrance appearance and acoustics

#### Specifications

**Frames (see p44-45)**  
Suits the INFR11 framing system

#### Matting Colours

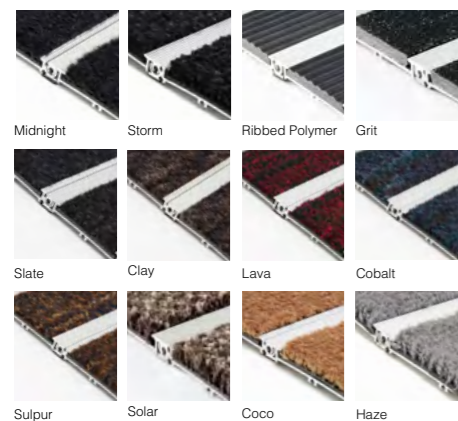

#### Aluminium Colours

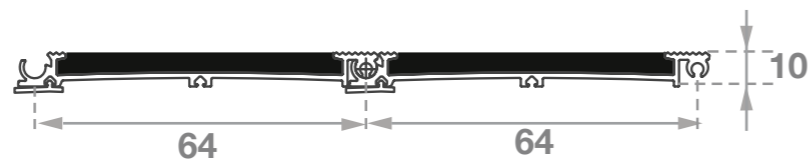
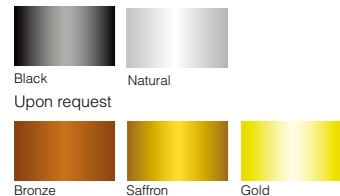

Suitable for high traffic applications	Easy interlocking system
Easy to clean. Highly effective scrape and wipe cleaning action	Made from recyclable materials
Wheelchair friendly	P5 Slip resistance rating
Rubber cushioned back for quietness underfoot	Fire test report available
Rolls up easily for cleaning	
Easily shaped for curved entrances or revolving doors	



## Classic Integra Vantt 7500

### Roll-up Aluminium Matting

#### Description

Classic Integra Vantt 7500 is for those that want that next level up in quality and style. The bold entrance statement made by the Vantt 7500 makes it the entrance mat of choice for the contemporary specifier. The Vantt 7500 innovative flexible interlocking system features an alternating pattern of aluminium scraper bars, with a twin colour dual width strip of the Zone non-static polyamide pile matting. For optimum results, install Vantt 7500 with the polymer scraper insert externally for slip resistance and removal of larger particles, and continue the mat through internally with the high quality dual width polyamide matting insert of the Vantt 7500 for that added 'touch of class'.

#### Application

Recess into mat wells, surface mount with ramp frame, wall-to-wall in airlocks and lobbies. Able to be cut into any shape or form providing the solution for architecturally shaped entrances and revolving doorways.

**Suitable for:** Commercial office buildings, shopping centres, hotels, motels, airports, schools and universities, hospitals and aged care homes, all public domains - libraries, etc.

#### Benefits

- Colour range co-ordinates with the Integra Zone range of matting and enables a cohesive colour flow
- Reduces cleaning time of surrounding floor finishes
- Minimises costly slip-and-fall accidents
- Stops dirt at the door for a cleaner environment
- Enhances entrance appearance and acoustics

#### Specifications

**Frames (see p44-45)**  
Suits the INFR11 framing system

#### Matting Colours

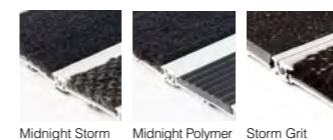

#### Aluminium Colours

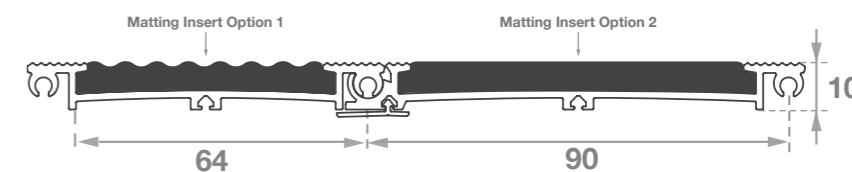
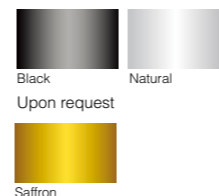

Suitable for high traffic applications	Easy interlocking system
Easy to clean. Highly effective scrape and wipe cleaning action	Made from recyclable materials
Wheelchair friendly	P5 Slip resistance rating
Rubber cushioned back for quietness underfoot	Fire test report available
Rolls up easily for cleaning	
Easily shaped for curved entrances or revolving doors	



# Classic Integra Vantt 9500

## Roll-up Aluminium Matting

### Description

Classic Integra Vantt 9500 is a new release in the Vantt range. The Vantt 9500 innovative flexible interlocking system features an alternating pattern of aluminium scraper bars, like the Vantt 5500. With a twin colour dual width strip of the Zone non-static polyamide pile matting, however the Vantt 9500 features a wider slat giving it a more 'carpet like' appearance. For optimum results, install Vantt 9500 with the polymer scraper insert externally for slip resistance and removal of larger particles, and continue the mat through internally with the high quality dual width polyamide matting insert of the Vantt 9500 for that added 'touch of class'.

### Application

Recess into mat wells, surface mount with ramp frame, wall-to-wall in airlocks and lobbies. Able to be cut into any shape or form providing the solution for architecturally shaped entrances and revolving doorways.

**Suitable for:** Commercial office buildings, shopping centres, hotels, motels, airports, schools and universities, hospitals and aged care homes, all public domains - libraries, etc.

### Benefits

- Colour range co-ordinates with the Integra Zone range of matting and enables a cohesive colour flow
- Reduces cleaning time of surrounding floor finishes
- Minimises costly slip-and-fall accidents
- Stops dirt at the door for a cleaner environment
- Enhances entrance appearance and acoustics

### Specifications

#### Frames (see p44-45)

Suits the INFR11 framing system

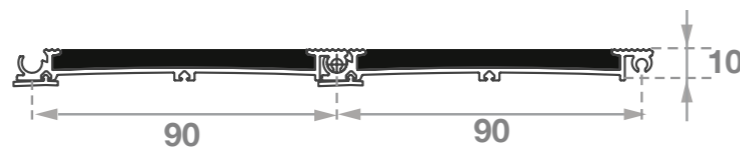

### Matting Colours



### Aluminium Colours

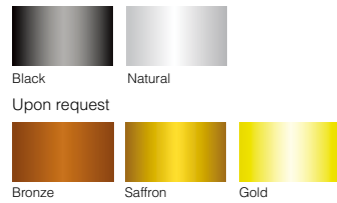

**LIFETIME  
WARRANTY**

**INSTALLATION  
SERVICES  
AVAILABLE**

**NCC  
COMPLIANT**

**AS1428  
COMPLIANT**

Suitable for high traffic applications	Easy interlocking system
Easy to clean. Highly effective scrape and wipe cleaning action	Made from recyclable materials
Wheelchair friendly	P5 Slip resistance rating
Rubber cushioned back for quietness underfoot	Fire test report available
Rolls up easily for cleaning	
Easily shaped for curved entrances or revolving doors	

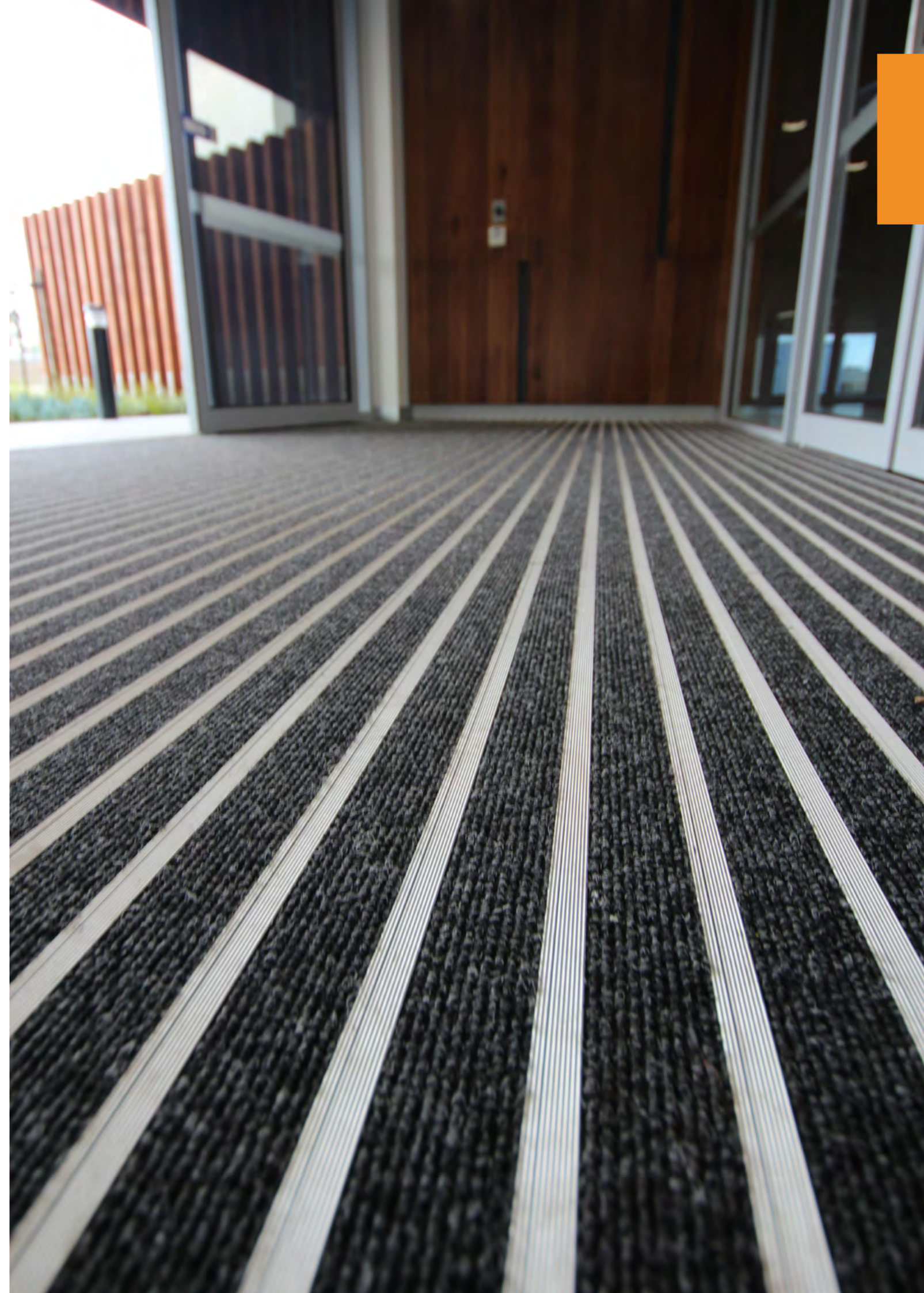

# Classic Integra Link

## Modular Interlocking Matting

- Modular tiles with easy interlocking system
- Durable and hard wearing
- Highly effective and easy to clean
- Medium to high traffic applications
- Interior and exterior use
- Wheelchair friendly
- Easy to transport and install



## Classic Integra Link Modular Interlocking Matting

### Description

Classic Integra Link features an open, yet heel-proof and wheelchair friendly design, incorporating non-static polyamide pile inserts coordinating with the Integra Zone range (allowing the cohesive colour flow of various matting zones). Can be simply rolled up for cleaning and maintenance. Non-metallic construction compatible for electronic security tagging systems in retail entrances. Creates a warm feel to any entrance.

### Application

Recess into mat wells, wall-to-wall in airlocks and lobbies.

**Suitable for:** Commercial office buildings, shopping centres, hotels, motels, airports, schools and universities, hospitals and aged care homes, all public domains - libraries, etc.

### Benefits

- Achieve unlimited size, colour and design combinations including patterns and borders
- Use the scrape tile on the exterior of your building then continue the style with the carpet insert version on the interior
- Simple interlocking tile system allows easy on-site mat construction and shaping without the need for specialised equipment
- Colour range coordinates with the Integra Zone range of matting and enables a cohesive colour flow
- Heel-proof to D.D.A. standards for peace of mind regarding OH&S
- Easy replacement of worn tiles
- Compatible with electronic tagging systems

### Specifications

#### Size

Modular interlocking tile 395mm x 135mm

#### Frames (see p44-45)

Suits the INFR17 framing system



### Insert Colours



Black Brush    Black Scrape    Grey Brush    Grey Scrape

**LIFETIME  
WARRANTY**

**INSTALLATION  
SERVICES  
AVAILABLE**

**NCC  
COMPLIANT**

**AS1428  
COMPLIANT**

- Suitable for medium to high traffic applications
- Easy to clean. Highly effective scrape and wipe cleaning action
- Modular system
- Heel-proof design
- Easy interlocking system
- Made from recyclable materials
- Wheelchair friendly
- Rolls up easily for cleaning
- P5 Slip resistance rating
- Fire test report available

# Classic Integra Zone

## Dirt and Moisture Barrier Carpet Style Matting

- Carpet style matting
- Special texturing and a thick, non-static pile
- Resistant to fungal and bacterial growth
- High fire resistant rating
- High water absorption
- Wide colour range
- High traffic applications
- Interior use
- Wheelchair friendly



## Classic Integra

# Zone

## Dirt and Moisture Barrier Carpet Style Matting

### Description

Classic Integra Zone architectural entrance matting has been proven in many highly demanding environments, as both a primary and as a secondary level of matting. The attractive, cut pile provides a luxurious look and feel, while the dual weave non-static polyamide fibre composition efficiently removes and absorbs water and grit. Integra Zone is incorporated into the Integra Vantt and Link matting ranges, allowing designer colour coordination and the cohesive flow of various matting zones.

### Colours



### Application

Can be installed as loose lay mats with bevelled edging, recessed into mat wells, or wall-to-wall in lobbies and atriums.

**Suitable for:** High traffic and high-end corporate entrances, hospitals, schools, universities, shopping centres, retail stores, stadiums, etc.

### Benefits

- Enhances interior appearance and acoustics
- Reduces floor maintenance and cleaning costs
- Minimises costly slip-and-fall accidents
- High water absorption
- Vinyl backing and edging helps reduce creeping
- Certified as meeting stringent international green ratings for environmentally friendly manufacture, recyclability and low VOC levels

### Specifications

#### Nominal Sizes

2000mm wide roll (including edging), custom cut to length.

#### Frames (see p44-45)

Suits the INFR08 framing system



**LIFETIME  
WARRANTY**

**INSTALLATION  
SERVICES  
AVAILABLE**

**NCC  
COMPLIANT**

**AS1428  
COMPLIANT**

Suitable for high traffic applications	LRV (Light Reflectance Value) - Refer to page 55 for details
Easy to clean	P5 Slip resistance rating
Resistant to fungal and bacterial growth	Fire test report available
Suitable for wheelchairs and other wheeled traffic	
Easy to transport and install	

# Classic Integra Zeal

## Dual Filament Carpet Style Matting

- Carpet style matting
- Low profile loop-pile design
- Easy to clean and crush resistant
- Medium to high traffic applications
- Interior use
- Wheelchair friendly



### Classic Integra

# Zeal 8850

## Dual Filament Carpet Style Matting

### Description

Classic Integra Zeal 8850 architectural entrance matting has been proven time and again. The lab tested design of this loop carpet style matting has been tested for extremely high traffic - more than 400,000 people per year. The hard wearing dual fibre provides a luxurious look, while effectively removing and hiding grime and grit.

### Application

High traffic, and high-end corporate entrances. Can be installed as loose lay mats with bevelled edging, recessed into mat wells, or wall-to-wall in lobbies and atriums.

**Suitable for:** Hospitals, schools, universities, shopping centres, etc.

### Benefits

- Traps dirt and particles at the base of the mat
- Easy removal of trapped dirt and particles when cleaning
- Enhances interior appearance and acoustics
- Reduces floor maintenance and cleaning costs
- Minimises costly slip-and-fall accidents
- Vinyl backing and edging helps reduce creeping

### Specifications

#### Nominal Sizes

2000mm wide roll (including edging), custom cut to length

#### Frames (see p44-45)

Suits the INFR08 framing system

### Colours



Ebony



**LIFETIME  
WARRANTY**

**INSTALLATION  
SERVICES  
AVAILABLE**

**NCC  
COMPLIANT**

**AS1428  
COMPLIANT**

- Suitable for high traffic applications
- Easy to clean
- Good dirt removal and hiding ability
- Suitable for wheelchairs and other wheeled traffic
- Low profile loop-pile design
- Releases trapped particles when vacuumed
- Easy to transport and install
- LRV (Light Reflectance Value) - Refer to page 55 for details
- P5 Slip resistance rating
- Fire test report available

# Classic Integra Premier

## Ribbed Carpet Style Matting

- Carpet style matting
- Ribbed chevron pattern design
- Releases trapped particles when vacuumed
- Medium to high traffic applications
- Interior use
- Wheelchair friendly



## Classic Integra Premier

### Ribbed Carpet Style Matting

#### Description

Classic Integra Premier has been specifically developed with a unique reinforced chevron pattern which provides a highly effective scraping action. Its special construction and the density of its polypropylene pile forms an effective moisture-absorbing barrier, competently arresting the spread of moisture, dirt and grit to maintain the life and safety of your floors.

#### Application

High traffic and high-end corporate entrances. Can be installed as loose lay mats with bevelled edging, recessed into mat wells, or wall-to-wall lobbies and atriums.

**Suitable for:** Hospitals, schools, shopping centres, etc.

#### Benefits

- Traps dirt and particles at the base of the mat
- Easy removal of trapped dirt and particles when cleaning
- Enhances interior appearance and acoustics
- Reduces floor maintenance and cleaning costs
- Minimises costly slip-and-fall accidents
- Vinyl backing and edging helps reduce creeping

#### Specifications

##### Nominal Sizes

1800mm wide roll, custom cut to length

##### Frames (see p44-45)

Suits the INFR08 framing system

#### Colours



Carbon



**LIFETIME WARRANTY**

**INSTALLATION SERVICES AVAILABLE**

**NCC COMPLIANT**

**AS1428 COMPLIANT**

- Suitable for medium to high traffic applications
- Easy to transport and install
- Easy to clean
- LRV (Light Reflectance Value) - Refer to page 55 for details
- Good dirt removal and hiding ability
- Fire test report available
- Suitable for wheelchairs and other wheeled traffic
- Low profile loop-pile design
- Releases trapped particles when vacuumed



# Classic Integra Tough

## Pebble Carpet Style Matting

- Unique pebble pattern for highly effective scraping
- Dense polypropylene pile provides excellent water and dirt retention
- Medium to high traffic applications
- Interior use
- Wheelchair friendly



## Classic Integra Tough

### Pebble Carpet Style Matting

#### Description

Classic Integra Tough has been specifically developed with a unique pebble pattern which provides a highly effective scraping action. Its special construction and the density of its polypropylene pile forms an effective moisture-absorbing barrier, competently arresting the spread of moisture, dirt and grit to maintain the life and safety of your floors.

#### Application

High traffic, and high-end corporate entrances. Can be installed recessed into mat wells, or wall-to-wall lobbies and atriums.

**Suitable for:** Schools, shopping centres, retail, community etc.

#### Benefits

- Easy removal of trapped dirt and particles when cleaning
- Excellent water and dirt retention
- Enhances interior appearance and acoustics
- Reduces floor maintenance and cleaning costs
- Minimises costly slip-and-fall accidents
- Latex backing for additional comfort

#### Specifications

##### Nominal Sizes

2000mm wide roll, custom cut to length

##### Frames (see p44-45)

Suits the INFR08 framing system

#### Colours



Charcoal



**LIFETIME  
WARRANTY**

**INSTALLATION  
SERVICES  
AVAILABLE**

**NCC  
COMPLIANT**

**AS1428  
COMPLIANT**

Suitable for medium to high traffic applications

Easy to transport and install

Easy to clean

LRV (Light Reflectance Value) - Refer to page 55 for details

Good dirt removal and hiding ability

Fire test report available

Suitable for wheelchairs and other wheeled traffic

Low profile loop-pile design

Releases trapped particles when vacuumed

# Classic Integra

# Matting Tiles

## Carpet Tile Matting

- Carpet style matting tiles
- Modular system
- Ribbed and plush options
- Dense polypropylene pile forms effective moisture absorbing barrier
- Medium to high traffic applications
- Interior use
- Easy to transport and install



## Classic Integra

# Urban Matting Tiles

## Plush Entrance Carpet Tile Matting

### Description

Classic Integra Urban Matting Tiles have been proven in many highly demanding environments, as both primary and as a secondary level of matting. The attractive, cut pile provides a luxurious look and feel, while the dual weave non-static polyamide fibre composition efficiently arrests the spread of moisture, dirt and grit to maintain the life and safety on your floors.

### Application

Recess into mat wells, wall-to-wall in airlocks and lobbies.

**Suitable for:** Commercial office buildings, shopping centres, hotels, motels, airports, schools and universities, hospitals and aged care homes, all public domains - libraries, etc.

### Benefits

- Achieve unlimited size combinations of colour and design including patterns and borders
- Simple tile system allows easy on-site mat construction, and shaping without the need for specialised equipment
- Easy removal of trapped dirt and particles when cleaning
- Enhances interior appearance and acoustics
- Reduces floor maintenance and cleaning costs
- Heel-proof to D.D.A. standards for peace of mind regarding OH&S
- Easy replacement of damaged tiles
- Compatible with electronic tagging systems

### Specifications

#### Nominal Sizes

Modular tile 500mm x 500mm

#### Frames (see p44-45)

Suits the INFR08 framing system

### Colours



Clay Shale Lava Slate



**LIFETIME  
WARRANTY**

**INSTALLATION  
SERVICES  
AVAILABLE**

**NCC  
COMPLIANT**

**AS1428  
COMPLIANT**

- Suitable for high traffic applications
- Easy to clean
- Good dirt removal and hiding ability
- Suitable for wheelchairs and other wheeled traffic
- Low profile tufted design
- Releases trapped particles when vacuumed
- Easy to transport and install
- Modular system
- Heel-proof design
- LRV (Light Reflectance Value) - Refer to page 55 for details
- P5 Slip resistance rating
- Fire test report available



# Classic Integra Studio Matting Tiles

## Ribbed Carpet Tile Matting

### Description

Classic Integra Studio Matting Tile has been specifically developed with a unique ribbed pattern which provides a highly effective scraping action. A highly effective moisture absorbing barrier is created by the polypropylene pile. The thick pile helping to absorb moisture, and the special construction enhancing the mats ability to capture grit and dirt.

### Application

Recess into mat wells, wall-to-wall in airlocks and lobbies.

**Suitable for:** Commercial office buildings, shopping centres, hotels, motels, airports, schools and universities, hospitals and aged care homes, all public domains - libraries, etc.

### Benefits

- Achieve unlimited size combinations and design including patterns and borders
- Modular tile system allows easy on-site mat installation and shaping without the need for specialised equipment
- Easy removal of trapped dirt and particles when cleaning
- Enhances interior appearance and acoustics
- Reduces floor maintenance and cleaning costs
- Heel-proof to D.D.A. standards for peace of mind regarding OH&S
- Easy replacement of worn tiles
- Compatible with electronic tagging systems

### Specifications

#### Nominal Sizes

Modular tile 500mm x 500mm

#### Frames (see p44-45)

Suits the INFR08 framing system



### Colours



Carbon



Suitable for medium to high traffic applications	Easy to transport and install
Easy to clean	Modular system
Good dirt removal and hiding ability	Heel-proof design
Suitable for wheelchairs and other wheeled traffic	LRV (Light Reflectance Value) - Refer to page 55 for details
Low profile tufted design	P5 Slip resistance rating
Releases trapped particles when vacuumed	Fire test report available

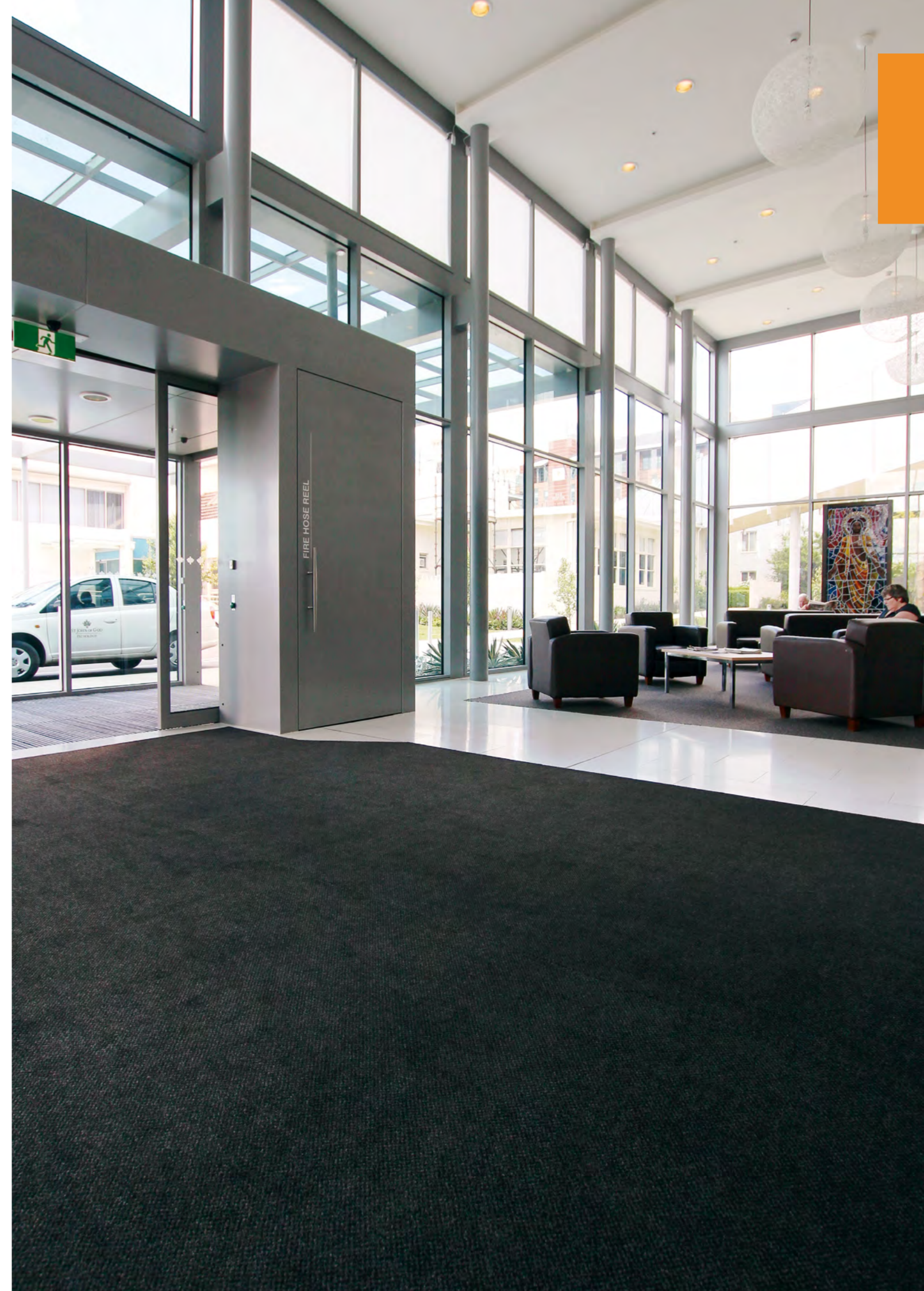

# Classic Integra Coir

## Natural Coir Matting

- Natural coconut fibre matting
- Environmentally friendly
- Moisture absorbent
- Low traffic applications
- Interior use



## Classic Integra Coir

### Natural Coir Matting

#### Description

Classic Integra Coir is made of natural coconut fibres, spun mechanically to give the mat a uniform and regular pattern with little fibre loss. The fibres are held together with a latex vinyl backing. This environmentally friendly product is the perfect quick fix.

#### Application

Recess into mat wells, wall-to-wall in airlocks and lobbies.

**Suitable for:** Churches, schools, hotels, motels, factories etc.

#### Benefits

- Environmentally friendly, made from natural coconut fibres
- Reduces floor maintenance and cleaning costs
- Minimises costly slip-and-fall accidents
- Three thicknesses to suit varying recess depths

#### Specifications

##### Nominal Sizes

2000mm wide roll (including edging), custom cut to length

##### Available Thicknesses

17mm, 23mm, 30mm

#### Colours



Black  
(Black only  
available in 17mm)

Natural



Suitable for low traffic applications



Moisture absorbent



Minimises slip-and-fall accidents



Easy to transport and install

**1YR**  
WARRANTY

INSTALLATION  
SERVICES  
AVAILABLE

# Classic Integra Zoit

## Dirt and Moisture Barrier Carpet Matting

- Carpet style matting
- Narrow, non-woven needlepunch carpet
- Ribbed design
- Resistant to fungal and bacterial growth
- High water absorption
- Low traffic applications
- Interior use



## Classic Integra

# Zoit

## Dirt and Moisture Barrier Carpet Matting

### Description

Classic Integra Zoit is a barrier carpet matting, featuring hard wearing 100% polypropylene fibre and Intraback latex backing. Its unique construction means that it will not zipper, fuzz or pill. Zoit is also resistant to insects, mould and mildew as well as being non-allergenic.

Classic Integra Zoit is incorporated into the Classic Integra Vantt matting range allowing designer colour coordination and the cohesive flow of various matting zones.

### Colours

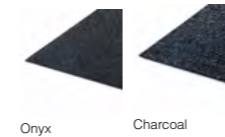

Onyx

Charcoal

### Application

Can be recessed into mat wells, or wall-to-wall in lobbies and atriums.

**Suitable for:** Commercial office buildings, apartments, churches, schools, hotels, motels, factories, etc.

### Benefits

- Enhances interior appearance and acoustics
- Reduces floor maintenance and cleaning costs
- Minimises costly slip-and-fall accidents

### Specifications

#### Nominal Sizes

2000mm wide roll, custom cut to length.

#### Frames (see p44-45)

Suits the INFR08 framing system



Suitable for low traffic applications



LRV (Light Reflectance Value) - Refer to page 55 for details



Ribbed design



Moisture absorbent



Minimises slip-and-fall accidents



Bacterial and fungal resistant



Easy to transport and install

**3YR**  
WARRANTY

INSTALLATION  
SERVICES  
AVAILABLE

# Classic Integra Shield

## Vinyl Scraper Matting

- Scraper entrance matting
- Durable and hard wearing
- Rolls up
- Resilient vinyl coiled construction, traps dirt
- UV resistant and withstands extreme temperatures
- High traffic applications
- Interior and exterior use, including snow and wet areas
- Wheelchair friendly

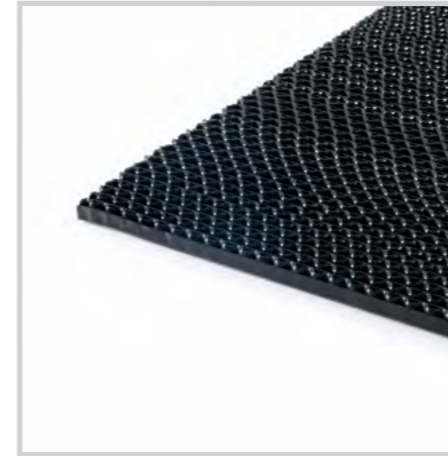

## Classic Integra Shield 9100 Vinyl Scraper Matting

### Description

Classic Integra Shield 9100 is an unbacked heavy duty 'Z-web' mat that is designed for recessed applications in demanding environments. The peaked edge of each web provides increased slip resistance and a very effective scraping action for dirt, grit and particle removal. Being unbacked means the trapped grit can easily pass through for easy clean up.

Also suitable for wet areas, such as snow regions removing compacted snow with ease. This matting will resist 'pack down' and has been lab tested for extremely high traffic levels - more than one million people per year.

### Application

Recessed into a mat well for high traffic areas. Suitable for snow and wet areas.

**Suitable for:** Commercial office buildings, apartments, churches, schools, hotels, motels, factories, etc.

### Benefits

- Thick and extremely durable
- Z-web construction allows dirt and moisture to easily pass through
- Able to withstand heavy traffic of up to 1 million footfalls per year
- Peaked edge provides a slip resistant surface
- Scrapes dirt and debris from shoes
- Able to withstand wheelchair and light wheel traffic

### Specifications

#### Nominal Sizes

1200mm wide roll, custom cut to length

#### Frames (see p44-45)

Suits the INFR11 framing system

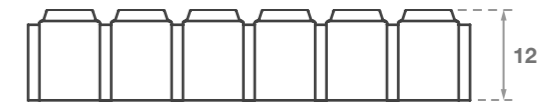

### Colours

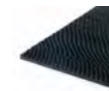

Ebony

**LIFETIME  
WARRANTY**

**INSTALLATION  
SERVICES  
AVAILABLE**

**NCC  
COMPLIANT**

**AS1428  
COMPLIANT**

- Suitable for high traffic applications
- Suitable for snow/wet areas
- Suitable for wheelchair and light wheel traffic
- Withstands extreme temperatures
- Easy to clean
- UV resistant and won't fade
- LRV (Light Reflectance Value) - Refer to page 55 for details
- P5 Slip resistance rating
- Fire test report available

# Classic Integra

# Mat Frames

- Entrance mat framing systems to suit all Classic Integra products
- Enhances entrance appearance
- Reduces custom fabrication cost and lead times
- Available in full lengths or cut to size
- Easy to transport and install

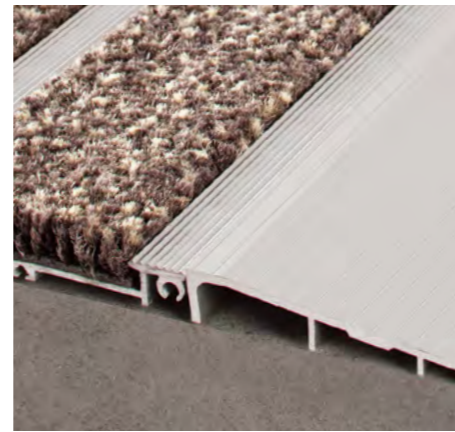

## Classic Integra INFR1180

Ramp Frame for Surface Mounted Matting

The Classic Integra ramp frame profile offers a solution for the surface mounting of an entrance mat or for providing a ramped transition to a small floor step.

### Benefits

- Provides a perfect finished appearance
- Use profile to create a defined mat well
- Provide compliant and safe pedestrian floor surfaces



Fire Resistant



AS1428 NCC Compliant

### Specifications

**Length** 5850mm **Height** 11mm O/A

**Width** 80mm

**Application**  
Ramp frame for 10-12mm matting

### Aluminium Colours



Black Natural

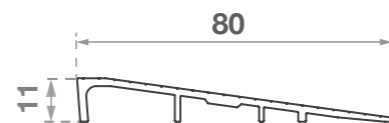

## Classic Integra INFR08

Framing System - Zone, Zeal, Premier, Tough, Urban, Studio, Zoit

The Classic Integra frame is the perfect partner for our range of architectural entrance matting to create a defined mat well and enhance the entrance appearance. It is designed to be installation friendly.

### Benefits

- Enhances entrance appearance
- Slimline profile for adhesive fix
- Available in full lengths or cut to size with mitred corners



Fire Resistant

### Specifications

**Length** 3000mm

**Recess** 10mm minimum

**Application**  
Suits 7-8mm matting

### Aluminium Colours



Natural  
Upon request



Black

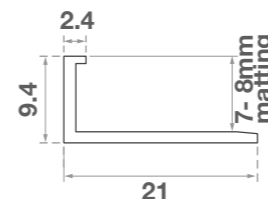

## Classic Integra INFR11

Framing System - Verse 12mm, Vantt, Shield

The Classic Integra frame is the perfect partner for our range of architectural entrance matting to create a defined mat well and enhance the entrance appearance. It is designed to be installation friendly and comes as a modular system complete with corner clips.

### Benefits

- Design eliminates the need for screeding
- Reduces costly custom fabrication cost and lead times
- Available in full lengths or cut to size with mitred corners



Fire Resistant

### Specifications

**Length** 5850mm

**Recess** 14mm minimum

**Application**  
Suits 10-12mm matting

### Aluminium Colours



Natural  
Black  
Upon request



Bronze Saffron Gold

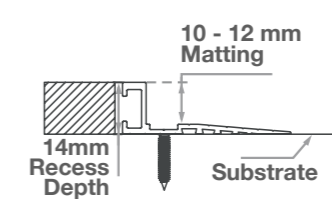

## Classic Integra INFR17

Framing System - Verse 17mm, Link, Coir 17mm

The Classic Integra frame is the perfect partner for our range of architectural entrance matting to create a defined mat well and enhance the entrance appearance. It is designed to be installation friendly and comes as a modular system complete with corner clips.

### Benefits

- Design eliminates the need for screeding
- Enhances entrance appearance
- Reduces costly custom fabrication cost and lead times
- Available in full lengths or cut to size with mitred corners



Fire Resistant

### Specifications

**Length** 5850mm

**Recess** 20mm minimum

**Application**  
Suits 16-17mm matting

### Aluminium Colours



Natural Black

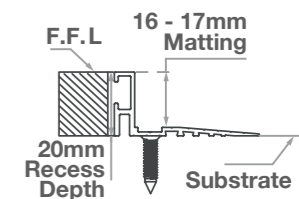

# Colour Guide

Classic Integra Entrance Matting comes in a wide range of colour options, catering to many styles, design aesthetics and project needs. Please note that these swatches are a guide only and actual colours may vary.

## Integra Verse

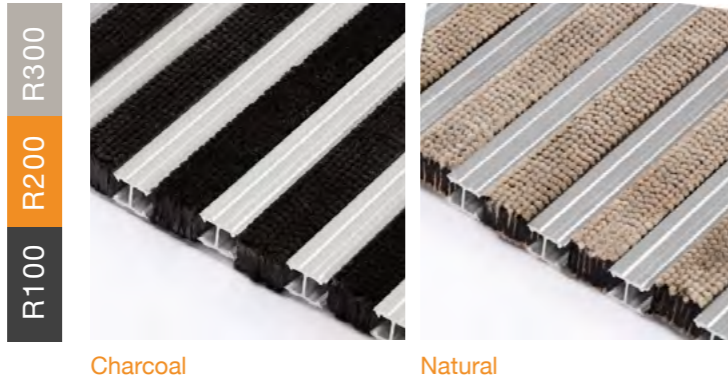

Charcoal

Natural

## Integra Vanttt

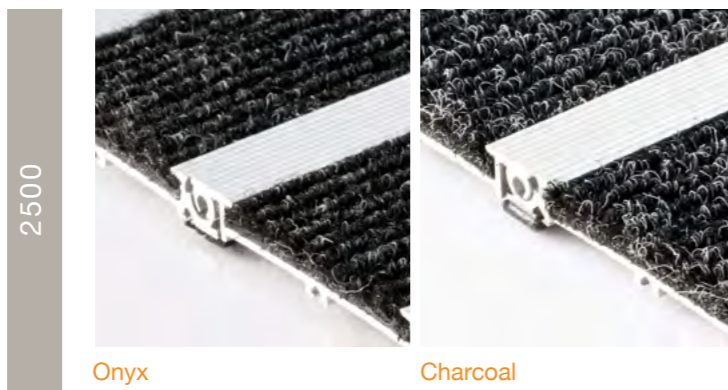

Onyx

Charcoal



Midnight

Storm

Ribbed Polymer



Lava

Sulphur

Solar



Grit

Slate

Clay

Cobalt



Haze

Coco



## Integra Vanttt

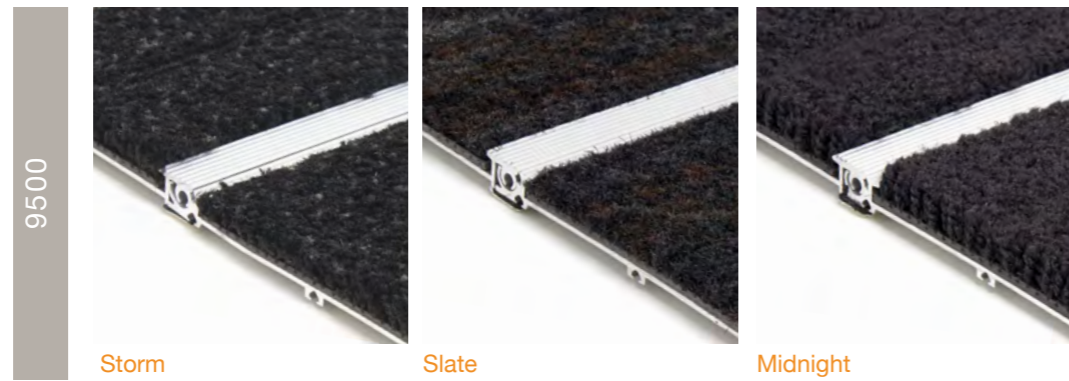
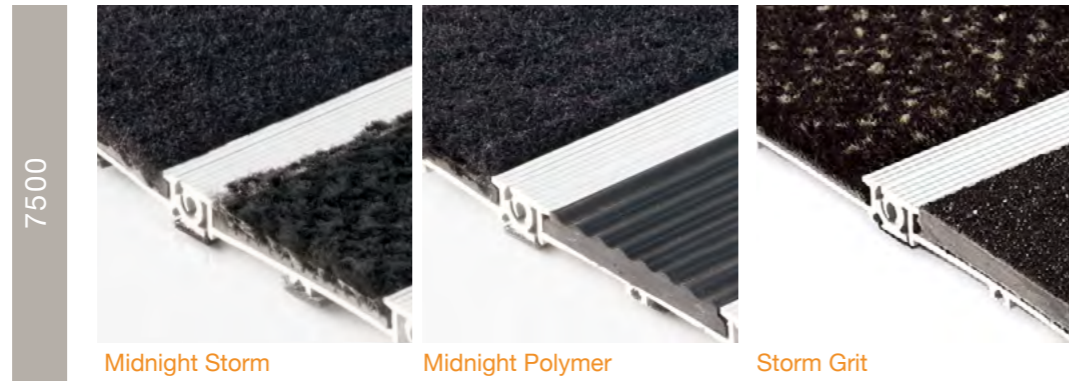

## Integra Link

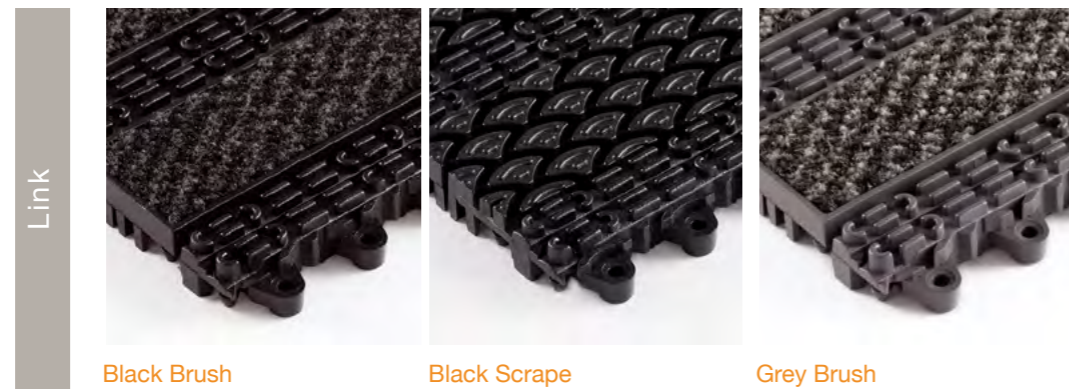

## Integra Zone

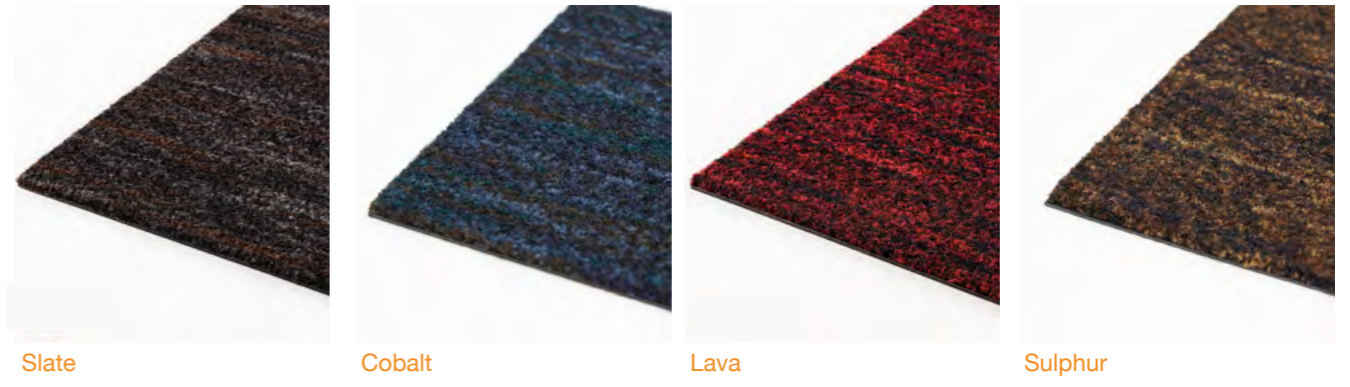

# Colour Guide

Zone



Shale



Haze



Coco

## Integra Zeal

8850



Ebony

## Integra Premier

Premier



Carbon

## Integra Tough

Tough



Charcoal



## Integra Matting Tiles

Urban

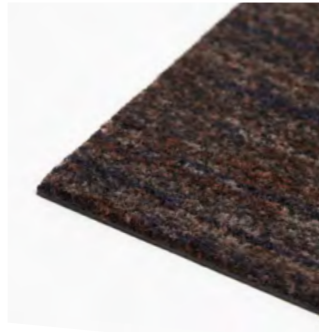

Clay



Shale



Lava



Slate

Studio



Carbon

## Integra Coir

Coir



Black



Natural

## Integra Zoit

Zoit



Onyx



Charcoal

## Integra Shield

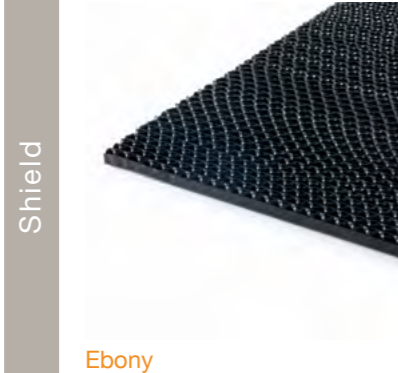

Shield

Ebony

# Entrance Matting LRV Guide

### What is luminance contrast testing?

Luminance contrast is a measure that compares the luminance reflectance of two different surfaces. Reports are produced from information collected on site, to document the compliance/non-compliance to building standards.

### Luminescent Test Results

All values shown were measured in accordance with the requirements of AS/NZS 1428.4.1:2009 & AS1428.1-2009 using a Konica Minolta Chroma meter CR-400/410 with a diffuse illumination/normal viewing (d/o) geometry and CIE D65 illuminant. The products were tested in multiple locations, and results have been averaged out, and rounded up to the nearest whole decimal. This data should be used as a guide only.

**Need luminance contrast testing on your project? Contact Classic now for advice.**

### CLASSIC INTEGRA ZONE MATTING

Colour	Dry
Midnight	1.9
Storm	1.5
Clay	2.1
Shale	3.0
Slate	1.4
Cobalt	1.6
Sulphur	2.9
Lava	2.1
Haze	9.5
Coco	12.1

### CLASSIC INTEGRA ZEAL 8850

Colour	Dry
Ebony	2.4

### CLASSIC INTEGRA PREMIER MATTING

Colour	Dry
Carbon	2.5

### CLASSIC INTEGRA TOUGH MATTING

Colour	Dry
Charcoal	2.1

### CLASSIC INTEGRA URBAN MATTING TILES

Colour	Dry
Clay	2.1
Shale	3.1
Lava	2.1
Slate	2.2

### CLASSIC INTEGRA STUDIO MATTING TILES

Colour	Dry
Carbon	3.1

### CLASSIC INTEGRA ZOIT MATTING

Colour	Dry
Onyx	1.6
Charcoal	3.6

### CLASSIC INTEGRA SHIELD 9100

Colour	Dry
Ebony	1.8

# STAIR NOSING

## WHY CHOOSE CLASSIC?

- Consultative approach
- Customised solutions
- End-to-end fulfilment
- Unrivalled knowledge of standards
- Lifetime warranty
- Over 40 years' experience
- People and operations across Australia

### Solid Brass



- Solid brass stair nosings
- Naturally beautiful aesthetic
- Ages gracefully
- Application types - surface mount, rebated, vinyl and rubber
- Large range of nosing insert colour options, available in ribbed polymer and grit
- Interior and exterior use
- Select a product with a slip resistant rating that suits your project's needs
- Complete the look with our solid brass tactile indicators, pg. 94

### Surface Mount

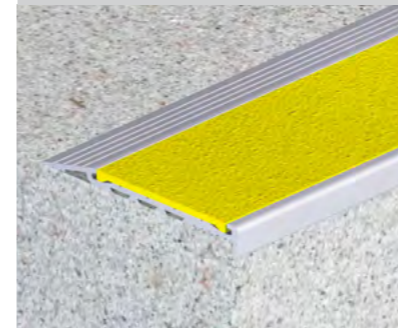

- Suitable for surface mount applications
- Contemporary appearance
- Hard wearing
- Aluminium nosings to suit wide range of substrates
- Ideal for retro-fitting and new staircases
- Large range of nosing insert options, available in aluminium, ribbed polymer, grit, luminescent and self-adhesive
- Options for interior and exterior use
- Select a product with a slip resistant rating that suits your project's needs
- Looking for solid brass? Refer pg. 58

### Carpet / Vinyl / Rubber

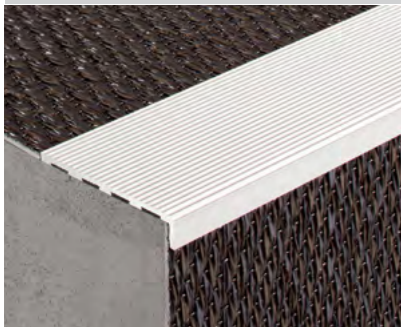

- Suitable for carpet, vinyl and rubber applications
- Contemporary appearance
- Hard wearing
- Aluminium nosings to suit wide range of substrates
- Large range of nosing insert colour options, available in ribbed polymer, ribbed metal, ribbed aluminium and grit
- Options for interior and exterior use
- Select a product with a slip resistant rating that suits your project's needs
- Looking for solid brass? Refer pg. 58

### Rebated - Timber / Tile



- Suitable for rebated applications - timber and tiles
- Modern, low profile and streamlined
- Hard wearing
- Aluminium nosings to suit wide range of substrates
- Large range of nosing insert colour options, available in ribbed polymer, ribbed aluminium and grit
- Interior and exterior use
- Select a product with a slip resistant rating that suits your project's needs
- Looking for solid brass? Refer pg. 58

### Fibreglass



- Fibreglass stair nosings
- Suitable for surface mount applications
- Ideal for industrial use
- Withstands extreme conditions
- Withstands high levels of moisture
- Resistant to most chemicals
- Non-conductive and fire resistant
- Highest P5 slip resistance rating
- Options for interior and exterior use

### Anti-Slip Tapes

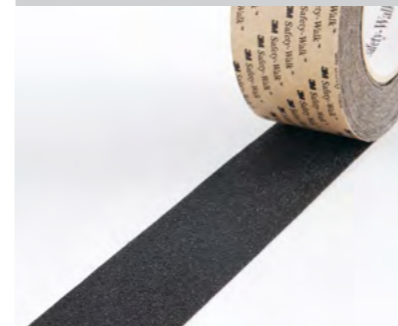

- Anti-slip tapes
- Self-adhesive for affordable and easy installation
- Ideal for access ramps
- Colours - black, yellow, clear and white
- Interior and exterior use
- Select a product with a slip resistant rating that suits your project's needs

### Accessories



- Accessories for stair nosings
- Adhesive options to assist with easy installation
- Suitable for Classic Tredfx stair nosings

# Classic Tredfx Solid Brass

## Stair Nosings

- Solid brass stair nosings
- Naturally beautiful aesthetic
- Ages gracefully
- Application types - surface mount, rebated, vinyl and rubber
- Large range of nosing insert colour options, available in ribbed polymer and grit
- Interior and exterior use
- Select a product with a slip resistant rating that suits your project's needs
- LRV wet and dry ratings, pg. 90
- Complete the look with our solid brass tactile indicators, pg. 94
- Looking for skate deterrents? Shop our Skatestop solid brass range, pg. 164

**LIFETIME  
WARRANTY**

**INSTALLATION  
SERVICES  
AVAILABLE**



### Classic Tredfx

## SNB041-H

Solid Brass Safety Stair Nosing for Multiple Applications

- Interior and exterior use
- Square back and square front



LRV Rating (pg 90)



P4 Slip Resistance Rating



Fire Resistant



AS1428 NCC Compliant

### Specifications

#### Length

5850mm (Cut-to-length service available)

#### Application

Surface Mount, Rebated, Vinyl, Rubber

#### Brass Colours



Natural Brass

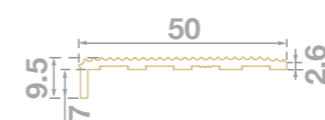

### Classic Tredfx

## SBR104-H

Solid Brass Safety Stair Nosing for Surface Mount Applications

- Interior and exterior use
- Ramped back, short raked front, pre-drilled and countersunk
- Ribbed polymer insert



LRV Rating (pg 90)



P3 Slip resistance rating



Fire test report available



AS1428 NCC Compliant

### Specifications

#### Length

5850mm (Cut-to-length service available)

#### Application

Surface Mount

#### Insert Colours



#### Upon request



#### Coral



Coral

#### Brass Colours



Natural Brass

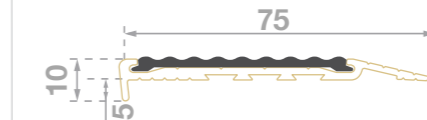

### Classic Tredfx

## DKR104-H

Solid Brass Safety Stair Nosing for Surface Mount Applications

- Interior and exterior use
- Ramped back, short raked front, pre-drilled and countersunk
- Grit insert



LRV Rating (pg 90)



P5 Slip resistance rating



Fire test report available



AS1428 NCC Compliant

### Specifications

#### Length

5850mm (Cut-to-length service available)

#### Application

Surface Mount

#### Insert Colours



#### Brass Colours



Natural Brass

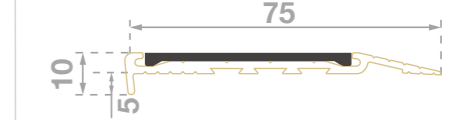



**Classic Tredfx**

**INB033-H**

Solid Brass Safety Stair Nosing for Rebated Applications

- Interior and exterior use
- Square edged



**Specifications**

**Length**  
5850mm (Cut-to-length service available)

**Application**  
Rebated

**Brass Colours**

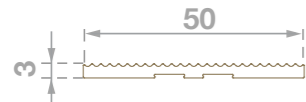

**Classic Tredfx**

**SBR142-H**

Solid Brass Safety Stair Nosing for Surface Mount Applications

- Interior and exterior use
- Ramped back and folded front
- Ribbed polymer insert
- Pre-drilled and countersunk



**Specifications**

**Length**  
5850mm (Cut-to-length service available)

**Application**  
Surface Mount

**Insert Colours**



**Brass Colours**

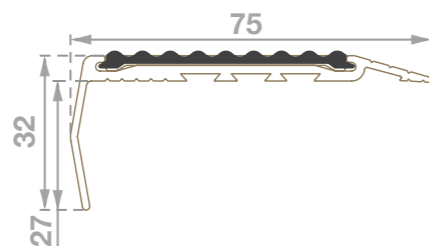

**Classic Tredfx**

**DKR142-H**

Solid Brass Safety Stair Nosing for Surface Mount Applications

- Interior and exterior use
- Ramped back and folded front
- Grit insert
- Pre-drilled and countersunk



**Specifications**

**Length**  
5850mm (Cut-to-length service available)

**Application**  
Surface Mount

**Insert Colours**



**Brass Colours**

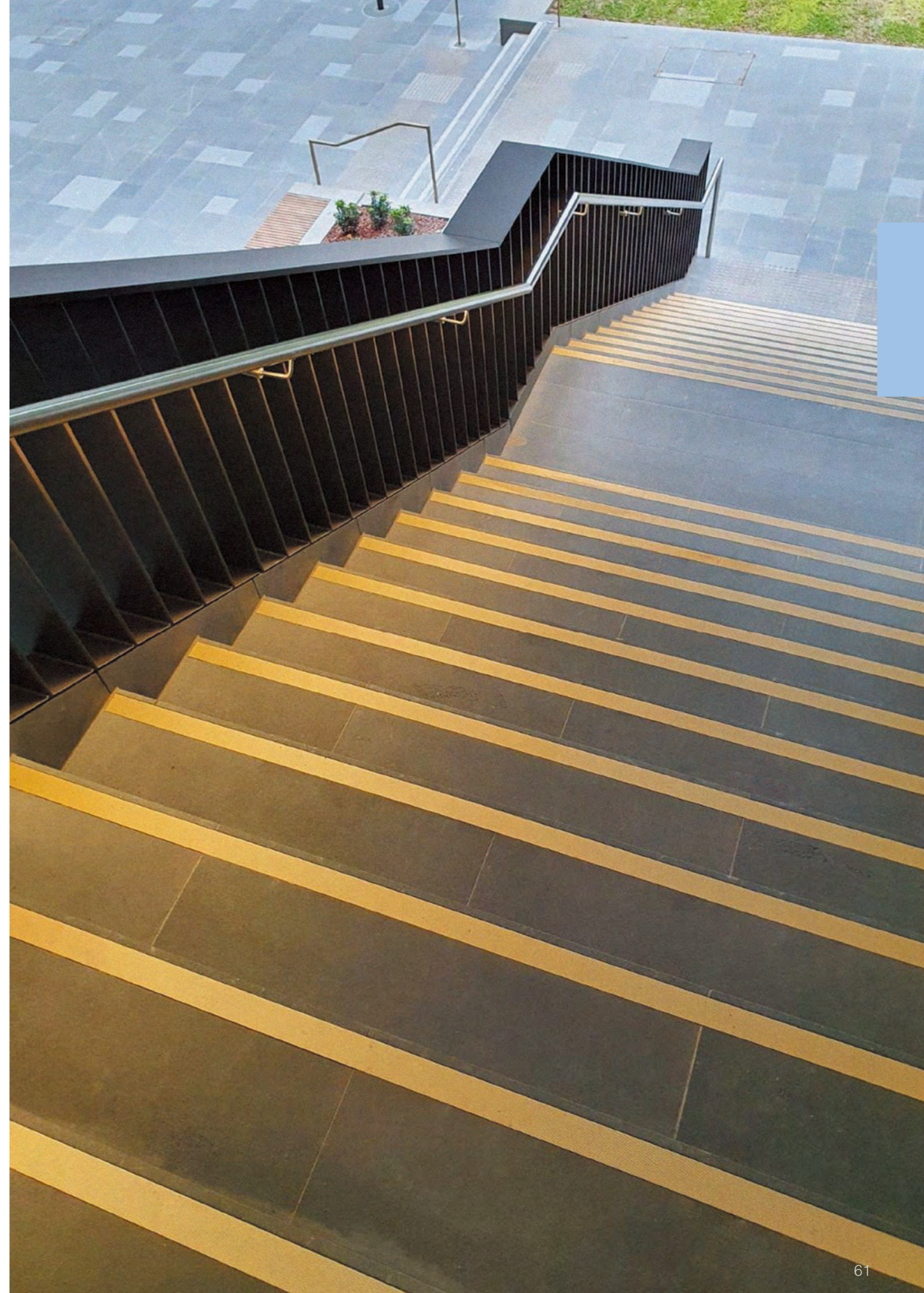
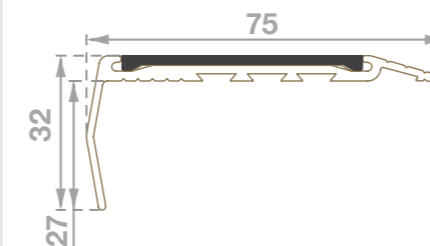

## Classic Tredfx

# Surface Mount

### Stair Nosings

- Suitable for surface mount applications
- Contemporary appearance
- Hard wearing
- Aluminium nosings to suit wide range of substrates
- Ideal for retro-fitting and new staircases
- Large range of nosing insert options, available in aluminium, ribbed polymer, grit, luminescent and self-adhesive
- Options for interior and exterior use
- Select a product with a slip resistant rating that suits your project's needs
- LRV wet and dry ratings, pg. 90
- Looking for solid brass? Refer pg. 58

**LIFETIME WARRANTY**

**INSTALLATION SERVICES AVAILABLE**



### Classic Tredfx

## SNR019

Aluminium Safety Stair Nosing for Surface Mount Applications

- Interior and exterior use
- Ramped back, short raked front



LRV Rating (pg 90)



P4 Slip resistance rating



Fire test report available



AS1428 NCC Compliant

#### Specifications

##### Length

5850mm (Cut-to-length service available)

##### Application

Surface Mount

##### Aluminium Colours



Black Natural

##### Upon request

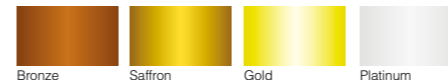

Bronze Saffron Gold Platinum

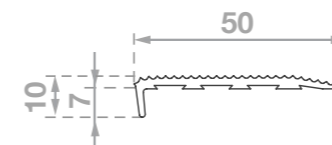

### Classic Tredfx

## SBR104

Aluminium Safety Stair Nosing for Surface Mount Applications

- Interior and exterior use
- Ramped back, folded front
- Ribbed polymer insert
- Pre-drilled and countersunk



LRV Rating (pg 90)



P3 Slip resistance rating



Fire test report available



AS1428 NCC Compliant

#### Specifications

##### Length

5850mm (Cut-to-length service available)

##### Application

Surface Mount

##### Insert Colours



Black Blue Dark Grey Red



Tangerine Mid Grey Yellow Beige



Light Grey White



Ultra Violet Raspberry Teal Lime Green



Coral

##### Aluminium Colours



Black Natural

##### Upon request



Bronze Saffron Gold

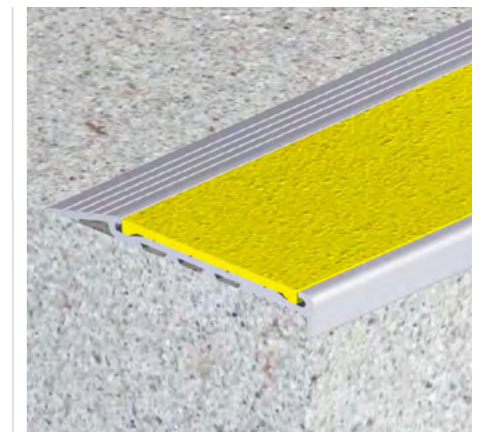
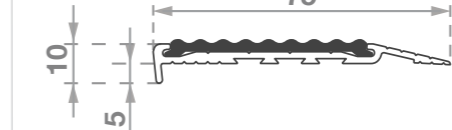

### Classic Tredfx

## DKR104

Aluminium Safety Stair Nosing for Surface Mount Applications

- Interior and exterior use
- Ramped back, short raked front
- Grit insert
- Pre-drilled and countersunk



LRV Rating (pg 90)



P5 Slip resistance rating



Fire test report available



AS1428 NCC Compliant

#### Specifications

##### Length

5850mm (Cut-to-length service available)

##### Application

Surface Mount

##### Insert Colours



Black Yellow Light Grey Luminescent



Black Natural



Bronze Saffron Gold



Bronze Saffron Gold



Bronze Saffron Gold



Black Natural

##### Upon request



Bronze Saffron Gold

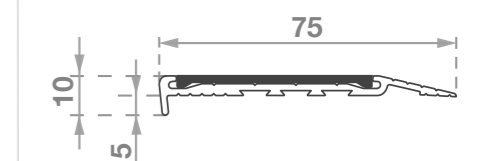





**Classic Tredfx**

**FMR104**

Aluminium Safety Stair Nosing for Surface Mount Applications

- Interior use
- Short raked front
- Aluminium insert
- Pre-drilled and countersunk



**Specifications**

**Length**  
5850mm (Cut-to-length service available)

**Application**  
Surface Mount

**Insert Colours**



**Aluminium Colours**

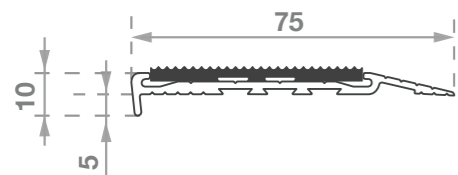
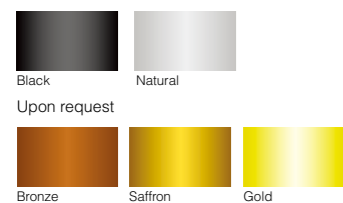

**Classic Tredfx**

**SBR103**

Aluminium Safety Stair Nosing for Surface Mount Applications

- Interior and exterior use
- Ramped back, folded front
- Ribbed polymer insert
- Pre-drilled and countersunk



**Specifications**

**Length**  
5850mm (Cut-to-length service available)

**Application**  
Surface Mount

**Insert Colours**

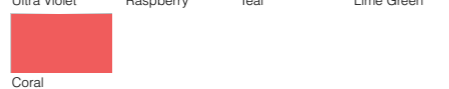

**Aluminium Colours**

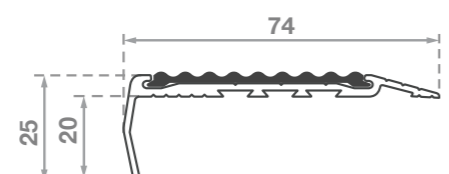
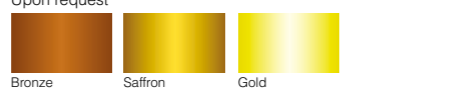

**Classic Tredfx**

**DKR103**

Aluminium Safety Stair Nosing for Surface Mount Applications

- Interior and exterior use
- Ramped back, folded front
- Grit insert
- Pre-drilled and countersunk



**Specifications**

**Length**  
5850mm (Cut-to-length service available)

**Application**  
Surface Mount

**Insert Colours**



**Aluminium Colours**

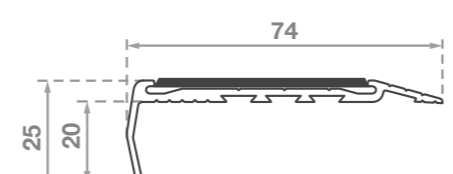

**Classic Tredfx**

**LBR128**

Aluminium Safety Stair Nosing for Surface Mount Applications

- Interior use
- Ramped back, short raked front
- Luminescent and polymer insert
- Pre-drilled and countersunk



**Specifications**

**Length**  
5850mm (Cut-to-length service available)

**Application**  
Surface Mount

**Insert Colours**



**Aluminium Colours**

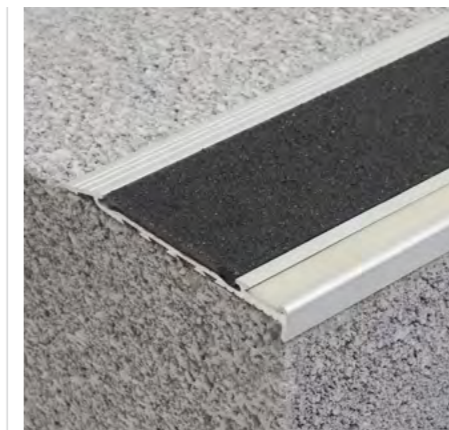
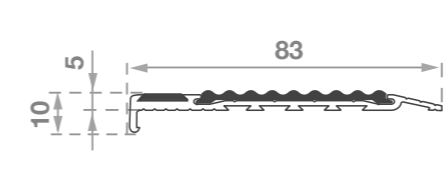

**Classic Tredfx**

**LKR128**

Aluminium Safety Stair Nosing for Surface Mount Applications

- Interior and exterior use
- Ramped back, short raked front
- Luminescent and grit insert
- Pre-drilled and countersunk



**Specifications**

**Length**  
5850mm (Cut-to-length service available)

**Application**  
Surface Mount

**Insert Colours**



**Aluminium Colours**

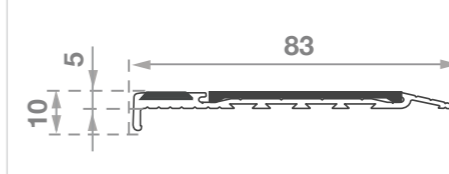

**Classic Tredfx**

**LBR127**

Aluminium Safety Stair Nosing for Surface Mount Applications

- Interior use
- Ramped back, folded front
- Luminescent and polymer insert
- Pre-drilled and countersunk



**Specifications**

**Length**  
5850mm (Cut-to-length service available)

**Application**  
Surface Mount

**Insert Colours**



**Aluminium Colours**

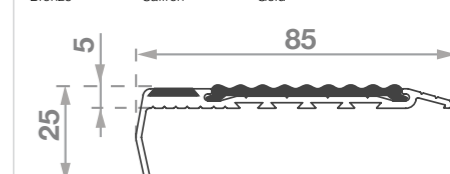
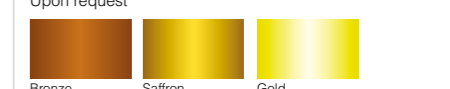



### Classic Tredfx LKR127

Aluminium Safety Stair Nosing for Surface Mount Applications

- Interior and exterior use
- Ramped back, folded front
- Luminescent and grit insert
- Pre-drilled and countersunk



#### Specifications

**Length**  
5850mm (Cut-to-length service available)

#### Application

Surface Mount

#### Insert Colours



#### Aluminium Colours

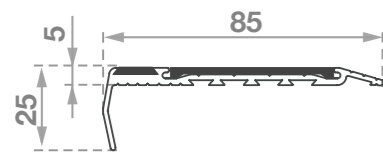
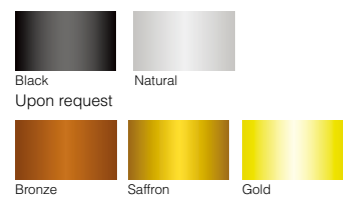

### Classic Tredfx SBR135

Aluminium Safety Stair Nosing for Surface Mount Applications

- Interior and exterior use
- Ramped back, long raked front
- Ribbed polymer insert
- Pre-drilled and countersunk



#### Specifications

**Length**  
5850mm (Cut-to-length service available)

#### Application

Surface Mount

#### Insert Colours



#### Aluminium Colours



#### Aluminium Colours

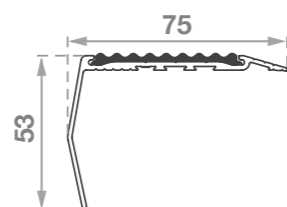
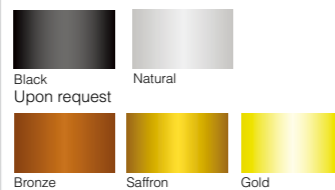

### Classic Tredfx DKR135

Aluminium Safety Stair Nosing for Surface Mount Applications

- Interior and exterior use
- Ramped back, long raked front
- Grit insert
- Pre-drilled and countersunk



#### Specifications

**Length**  
5850mm (Cut-to-length service available)

#### Application

Surface Mount

#### Insert Colours

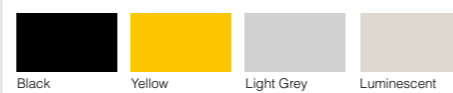

#### Aluminium Colours

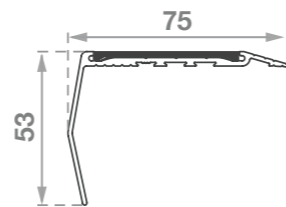

### Classic Tredfx DKR404

Aluminium Safety Stair Nosing for Surface Mount Applications

- Interior and exterior use
- Ramped back, short raked front
- Grit insert
- Pre-drilled and countersunk



#### Specifications

**Length**  
5850mm (Cut-to-length service available)

#### Application

Surface Mount

#### Insert Colours



#### Aluminium Colours

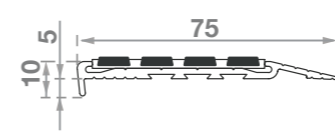

### Classic Tredfx LKR428

Aluminium Safety Stair Nosing for Surface Mount Applications

- Interior and exterior use
- Ramped back, short raked front
- Luminescent and grit insert
- Pre-drilled and countersunk



#### Specifications

**Length**  
5850mm (Cut-to-length service available)

#### Application

Surface Mount

#### Insert Colours



#### Aluminium Colours

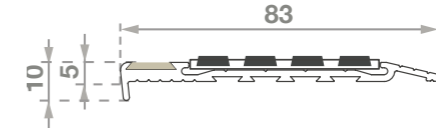

### Classic Tredfx DKR403

Aluminium Safety Stair Nosing for Surface Mount Applications

- Interior and exterior use
- Ramped back
- Grit insert
- Pre-drilled and countersunk



#### Specifications

**Length**  
5850mm (Cut-to-length service available)

#### Application

Surface Mount

#### Insert Colours



#### Aluminium Colours

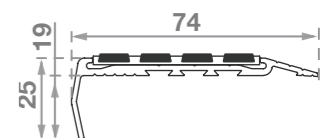
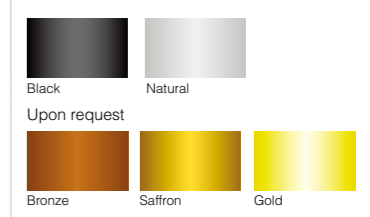

Surface Mount



Classic Tredfx

LKR427

Aluminium Safety Stair Nosing for Surface Mount Applications

- Interior and exterior use
- Ramped back, folded front
- Luminescent and grit insert
- Pre-drilled and countersunk



LRV Rating (pg 90)



P5 Slip resistance rating



Fire test report available

Specifications

Length

5850mm (Cut-to-length service available)

Application

Surface Mount

Insert Colours



Aluminium Colours



Upon request

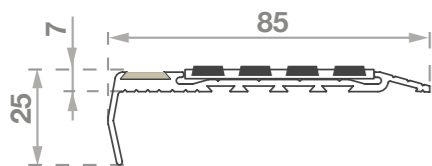

Classic Tredfx

DKR435

Aluminium Safety Stair Nosing for Surface Mount Applications

- Interior and exterior use
- Ramped back, long raked front
- Grit insert
- Pre-drilled and countersunk



LRV Rating (pg 90)



P5 Slip resistance rating



Fire test report available

Specifications

Length

5850mm (Cut-to-length service available)

Application

Surface Mount

Insert Colours



Aluminium Colours



Upon request

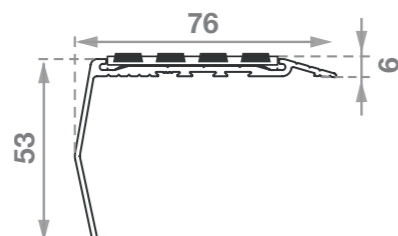

Classic Tredfx

A-138R

Aluminium Safety Stair Nosing for Surface Mount Applications

- Interior and exterior use
- Anodised aluminium in natural (satin silver) finish
- Low profile, with ramped back edge to avoid trip hazards
- 1 x 50mm non-slip self-adhesive insert (Black or yellow)
- Standard 3650mm lengths (packs of 10 lengths)
- Supplied with adhesive



LRV Rating (pg 90)



P5 Slip resistance rating



Fire test report available



AS1428 NCC Compliant

Specifications

Length

3650mm

Application

Surface Mount

Insert Colours



Black Yellow

Upon request



White Grey



Classic Tredfx

A-137R

Aluminium Safety Stair Nosing for Surface Mount Applications

- Interior and exterior use
- Anodised aluminium in natural (satin silver) finish
- Low profile, with ramped back edge to avoid trip hazards
- 1 x 50mm non-slip self-adhesive insert (Black or yellow)
- Standard 3650mm lengths (packs of 10 lengths)
- Supplied with adhesive



LRV Rating (pg 90)



P5 Slip resistance rating



Fire test report available

Specifications

Length

3650mm

Application

Surface Mount

Insert Colours



Black Yellow

Upon request



White Grey

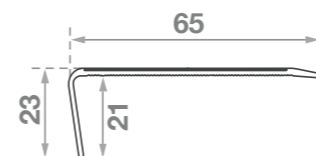

Classic Tredfx

# Carpet / Vinyl / Rubber

Stair Nosings

- Contemporary appearance
- Hard wearing
- Aluminium nosings to suit wide range of substrates
- Large range of nosing insert colour options, available in ribbed polymer, ribbed metal, ribbed aluminium and grit
- Options for interior and exterior use
- Select a product with a slip resistant rating that suits your project's needs
- LRV wet and dry ratings, pg. 90
- Looking for solid brass? Refer pg. 58

**LIFETIME WARRANTY**  
**INSTALLATION SERVICES AVAILABLE**

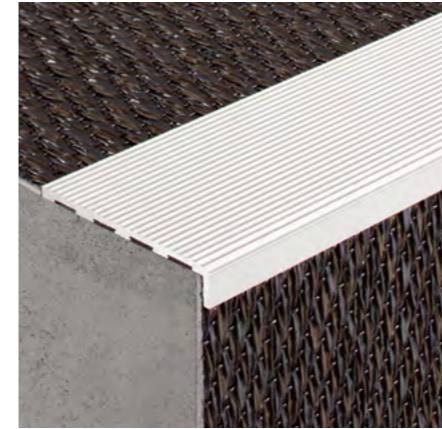

## Classic Tredfx

### SNB031

Aluminium Safety Stair Nosing for Vinyl / Rubber

- Interior and exterior use
- Square back, short square front



#### Specifications

**Length**  
5850mm (Cut-to-length service available)

**Application**  
Vinyl / Rubber (suits 3mm rebate)

#### Aluminium Colours

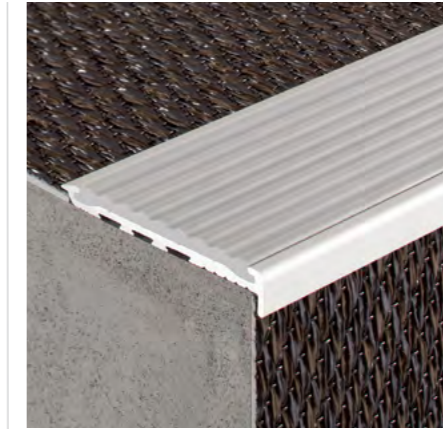
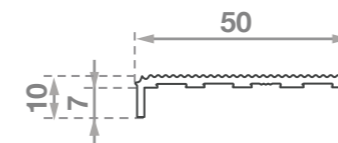

## Classic Tredfx

### SBV105

Aluminium Safety Stair Nosing for Vinyl / Rubber

- Interior and exterior use
- Gripper back, short raked front
- Ribbed polymer insert
- Pre-drilled and countersunk



#### Specifications

**Length**  
5850mm (Cut-to-length service available)

**Application**  
Vinyl / Rubber (suits 2mm thickness)

#### Insert Colours



#### Aluminium Colours

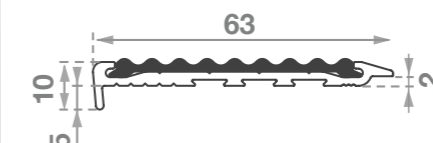
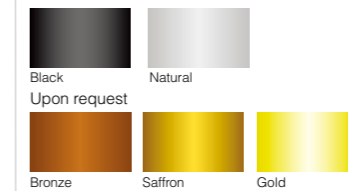

## Classic Tredfx

### DKV105

Aluminium Safety Stair Nosing for Vinyl / Rubber

- Interior and exterior use
- Gripper back, short raked front
- Grit insert
- Pre-drilled and countersunk



#### Specifications

**Length**  
5850mm (Cut-to-length service available)

**Application**  
Vinyl / Rubber (suits 2mm thickness)

#### Insert Colours

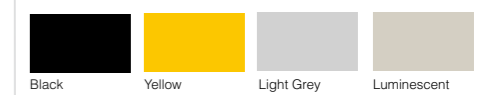

#### Aluminium Colours

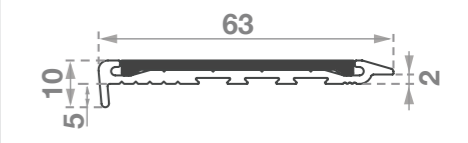
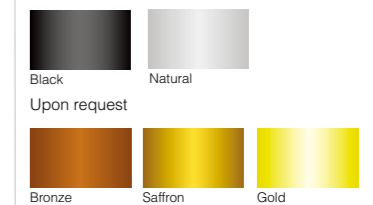

Multiple Applications

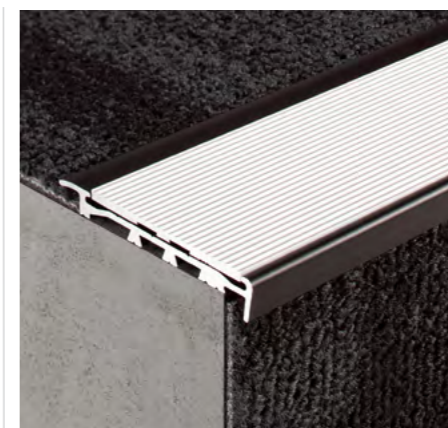
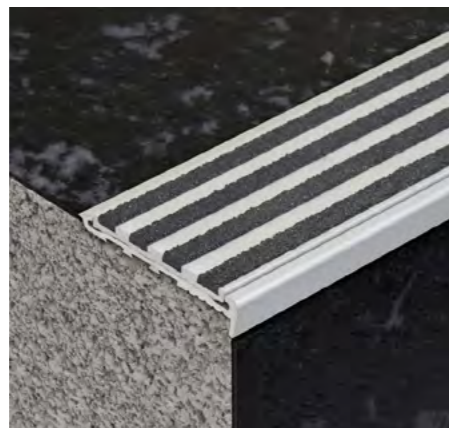

**Classic Tredfx**  
**FMV105**

Aluminium Safety Stair Nosing for Vinyl / Rubber

- Interior use
- Gripper back, short raked front
- Ribbed metal insert
- Pre-drilled and countersunk



**Specifications**

**Length**  
5850mm (Cut-to-length service available)

**Application**  
Vinyl / Rubber (suits 2mm thickness)

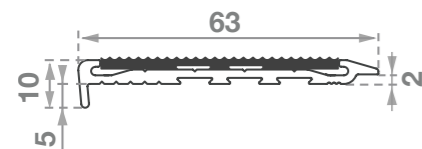
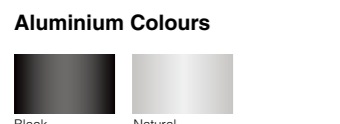
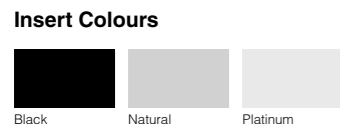

**Classic Tredfx**  
**DKV405**

Aluminium Safety Stair Nosing for Vinyl / Rubber

- Interior and exterior use
- Gripper back, short raked front
- Grit insert
- Pre-drilled and countersunk



**Specifications**

**Length**  
5850mm (Cut-to-length service available)

**Application**  
Vinyl / Rubber (suits 2mm thickness)

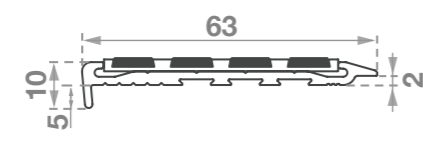
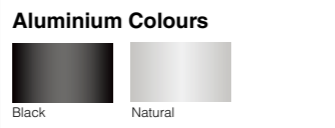
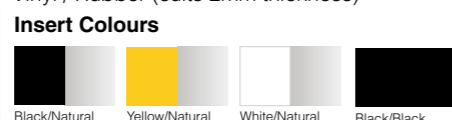

**Classic Tredfx**  
**PBD106**

Aluminium Safety Stair Nosing for Carpet / Rubber

- Interior use
- Gripper back, short raked front
- Ribbed polymer insert
- Pre-drilled and countersunk

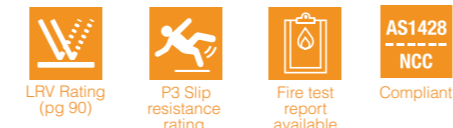

**Specifications**

**Length**  
5850mm (Cut-to-length service available)

**Application**  
Carpet / Rubber (suits 4-6mm thickness)

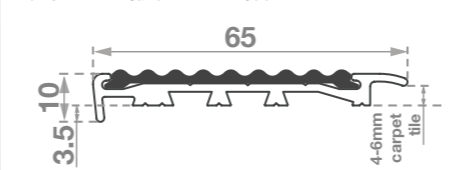
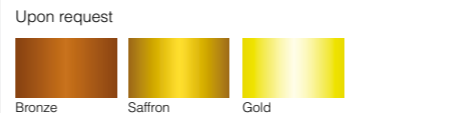
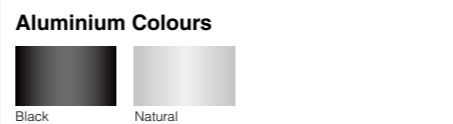
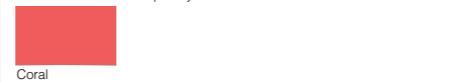
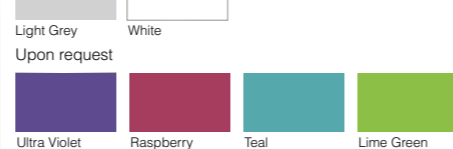
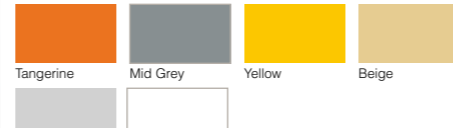

**Classic Tredfx**  
**PKD106**

Aluminium Safety Stair Nosing for Carpet / Rubber

- Interior use
- Gripper back, short raked front
- Grit insert
- Pre-drilled and countersunk

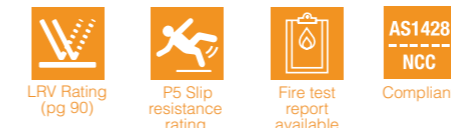

**Specifications**

**Length**  
5850mm (Cut-to-length service available)

**Application**  
Carpet / Rubber (suits 4-6mm thickness)

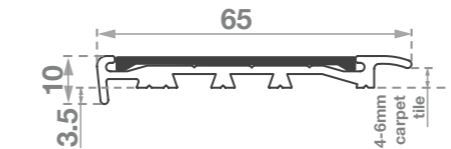
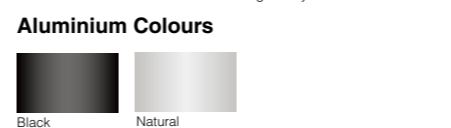

**Classic Tredfx**  
**FMD106**

Aluminium Safety Stair Nosing for Carpet / Rubber

- Interior use
- Gripper back, short raked front
- Ribbed metal insert
- Pre-drilled and countersunk



**Specifications**

**Length**  
5850mm (Cut-to-length service available)

**Application**  
Carpet / Rubber (suits 4-6mm thickness)

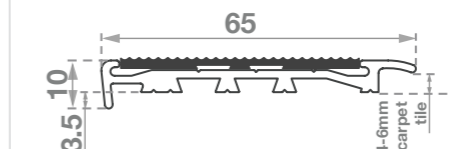

**Classic Tredfx**  
**PKD406**

Aluminium Safety Stair Nosing for Carpet / Rubber

- Interior use
- Gripper back, short raked front
- Grit insert
- Pre-drilled and countersunk



**Specifications**

**Length**  
5850mm (Cut-to-length service available)

**Application**  
Carpet / Rubber (suits 4-6mm thickness)

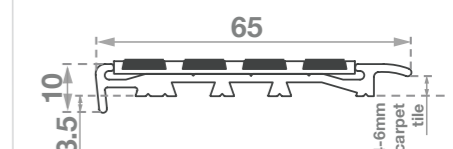
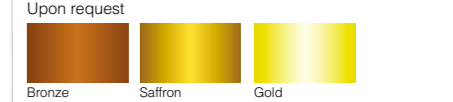
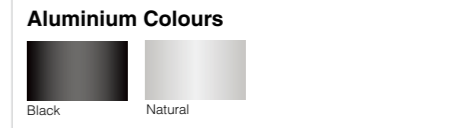
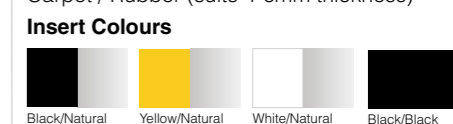

Multiple Applications

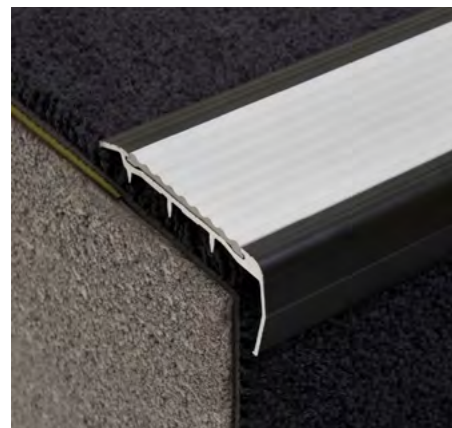

Classic Tredfx

PBC102

Aluminium Safety Stair Nosing for Carpet Applications

- Interior use
- Gripper back, folded front
- Ribbed polymer insert
- Pre-drilled and countersunk



LRV Rating (pg 90)



P3 Slip resistance rating



Fire test report available

Specifications

Length

5850mm (Cut-to-length service available)

Application

Carpet

Insert Colours



Aluminium Colours

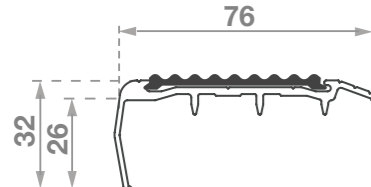
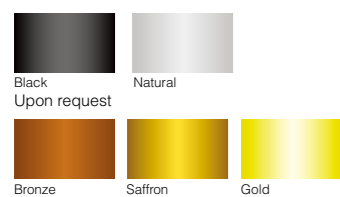

Classic Tredfx

PBD129

Aluminium Safety Stair Nosing for Carpet / Rubber

- Interior use
- Gripper back, folded front
- Ribbed polymer insert
- Pre-drilled and countersunk



LRV Rating (pg 90)



P3 Slip resistance rating



Fire test report available

Specifications

Length

5850mm (Cut-to-length service available)

Application

Carpet / Rubber (suits 4-6mm thickness)

Insert Colours



Aluminium Colours

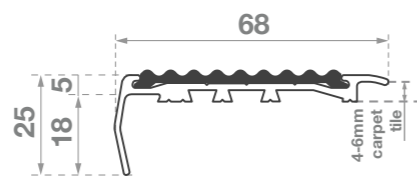

Classic Tredfx

PKD129

Aluminium Safety Stair Nosing for Carpet / Rubber

- Interior use
- Gripper back, folded front
- Grit insert
- Pre-drilled and countersunk



LRV Rating (pg 90)



P5 Slip resistance rating



Fire test report available

Specifications

Length

5850mm (Cut-to-length service available)

Application

Carpet / Rubber (suits 4-6mm thickness)

Insert Colours



Aluminium Colours

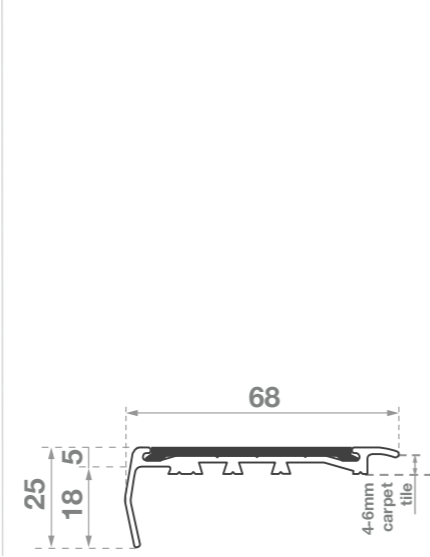

Classic Tredfx

FMD129

Aluminium Safety Stair Nosing for Carpet / Rubber

- Interior use
- Gripper back, folded front
- Ribbed aluminium insert
- Pre-drilled and countersunk



LRV Rating (pg 90)



P4 Slip resistance rating



Fire Resistant

Specifications

Length

5850mm (Cut-to-length service available)

Application

Carpet / Rubber (suits 4-6mm thickness)

Insert Colours



Aluminium Colours

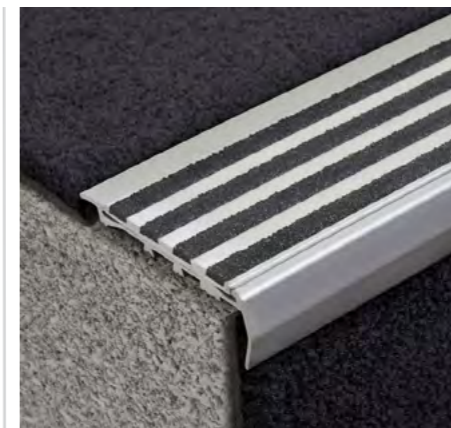
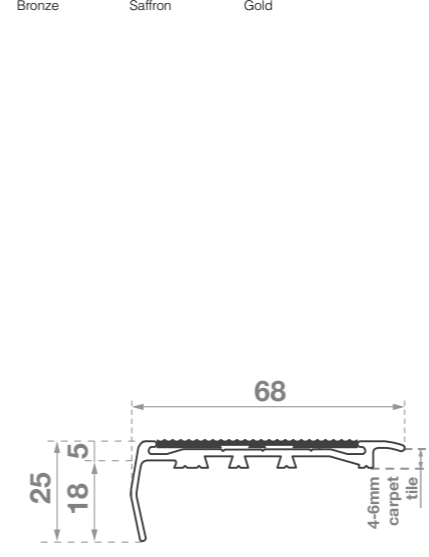

Classic Tredfx

PKD429

Aluminium Safety Stair Nosing for Carpet / Rubber

- Interior use
- Gripper back, folded front
- Grit insert
- Pre-drilled and countersunk



LRV Rating (pg 90)



P5 Slip resistance rating



Fire test report available

Specifications

Length

5850mm (Cut-to-length service available)

Application

Carpet / Rubber (suits 4-6mm thickness)

Insert Colours



Aluminium Colours

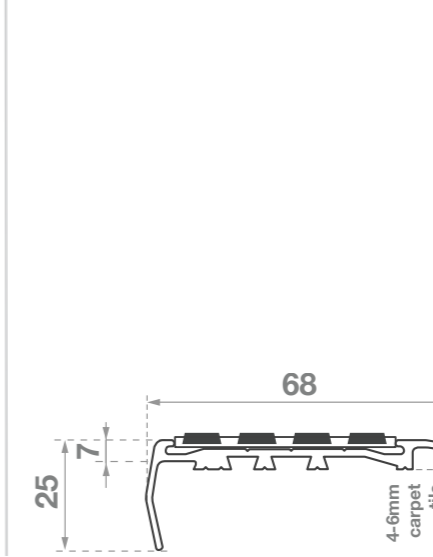
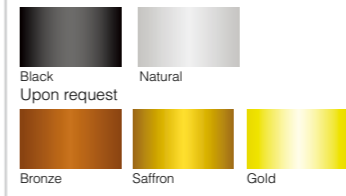

Classic Tredfx

PND045

Aluminium Safety Stair Nosing for Carpet Applications

- Interior use
- Gripper back, short raked front
- Ribbed top



LRV Rating (pg 90)



P4 Slip resistance rating



Fire test report available



AS1428 NCC Compliant

Specifications

Length

5850mm (Cut-to-length service available)

Application

Carpet (suits 8-10mm thickness)

Aluminium Colours

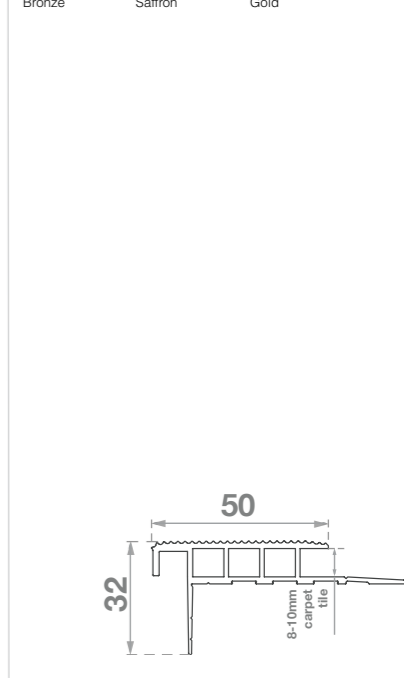
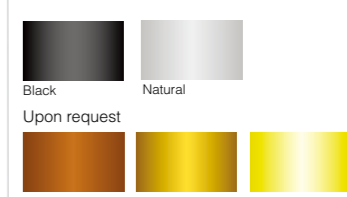

Multiple Applications



Classic Tredfx

PND046

Aluminium Safety Stair Nosing for Carpet Applications

- Interior use
- Gripper back, short raked front
- Ribbed top



Specifications

**Length**  
5850mm (Cut-to-length service available)

**Application**  
Carpet (suits 4-6mm thickness)

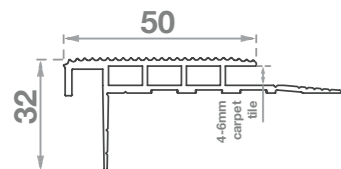

Classic Tredfx

PBD143

Aluminium Safety Stair Nosing for Carpet Applications

- Interior use
- Gripper back, short raked front
- Ribbed polymer insert



Specifications

**Length**  
5850mm (Cut-to-length service available)

**Application**  
Carpet (suits 8-10mm thickness)

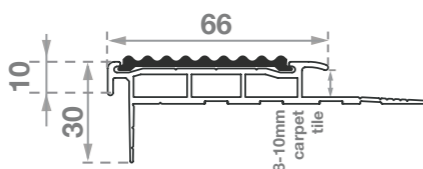

Classic Tredfx

PKD143

Aluminium Safety Stair Nosing for Carpet Applications

- Interior use
- Gripper back, short raked front
- Grit insert



Specifications

**Length**  
5850mm (Cut-to-length service available)

**Application**  
Carpet (suits 8-10mm thickness)

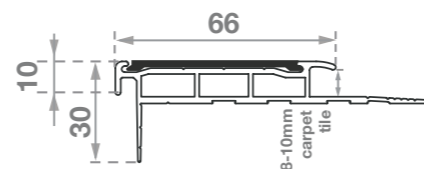

Classic Tredfx

PKD443

Aluminium Safety Stair Nosing for Carpet Applications

- Interior use
- Gripper back and short raked front
- Grit insert



Specifications

**Length**  
5850mm (Cut-to-length service available)

**Application**  
Carpet (suits 8-10mm thickness)

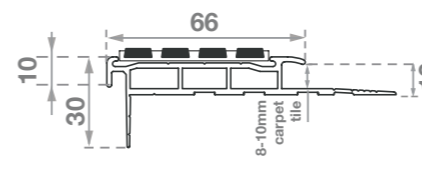
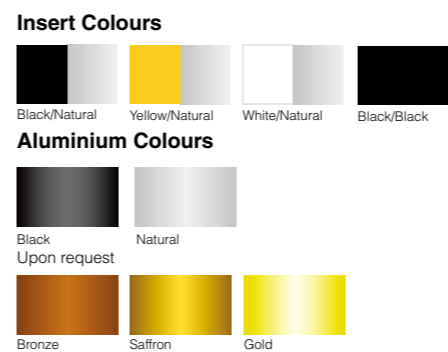

Classic Tredfx

PBD144

Aluminium Safety Stair Nosing for Carpet Applications

- Interior use
- Gripper back, short raked front
- Ribbed polymer insert



Specifications

**Length**  
5850mm (Cut-to-length service available)

**Application**  
Carpet (suits 4-6mm thickness)

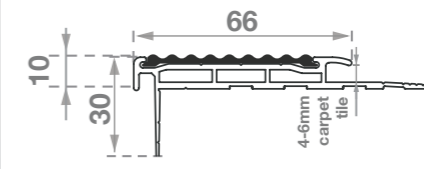

Classic Tredfx

PKD144

Aluminium Safety Stair Nosing for Carpet Applications

- Interior use
- Gripper back, short raked front
- Grit insert



Specifications

**Length**  
5850mm (Cut-to-length service available)

**Application**  
Carpet (suits 4-6mm thickness)

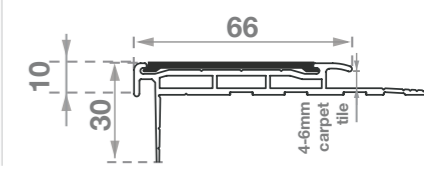

## Multiple Applications



### Classic Tredfx

## PKD444

Aluminium Safety Stair Nosing  
for Carpet Applications

- Interior use
- Gripper back, short raked front
- Grit insert



LRV Rating  
(pg 90)



P5 Slip  
resistance  
rating



Fire  
Resistant

### Specifications

#### Length

5850mm (Cut-to-length service available)

#### Application

Carpet (suits 4-6mm thickness)

#### Insert Colours



#### Aluminium Colours

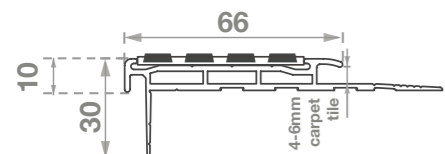
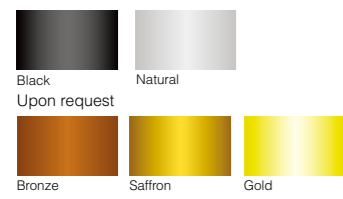



Classic Tredfx

# Rebated - Timber / Tile

Stair Nosings

- Suitable for rebated applications - timber and tiles
- Modern, low profile and streamlined
- Hard wearing
- Aluminium nosings to suit wide range of substrates
- Large range of nosing insert colour options, available in ribbed polymer, ribbed aluminium and grit
- Interior and exterior use
- Select a product with a slip resistant rating that suits your project's needs
- LRV wet and dry ratings, pg. 90
- Looking for solid brass? refer pg. 58

**LIFETIME WARRANTY**

**INSTALLATION SERVICES AVAILABLE**



**Classic Tredfx**

## INB033

Aluminium Safety Stair Nosing for Rebated Applications

- Interior and exterior use
- Square back, square front
- Ribbed metal



### Specifications

#### Length

5850mm (Cut-to-length service available)

#### Application

Rebated - Timber / Tile

#### Aluminium Colours



**Classic Tredfx**

## IBB121

Aluminium Safety Stair Nosing for Rebated Applications

- Interior and exterior use
- Square back, square front
- Ribbed polymer insert
- Pre-drilled and countersunk



### Specifications

#### Length

5850mm (Cut-to-length service available)

#### Application

Rebated - Timber / Tile

#### Insert Colours



#### Aluminium Colours



**Classic Tredfx**

## IKB121

Aluminium Safety Stair Nosing for Rebated Applications

- Interior and exterior use
- Square back, square front
- Grit insert
- Pre-drilled and countersunk



### Specifications

#### Length

5850mm (Cut-to-length service available)

#### Application

Rebated - Timber / Tile

#### Insert Colours



#### Aluminium Colours

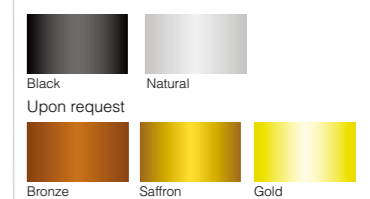



**Classic Tredfx**

**IMB121**

Aluminium Safety Stair Nosing for Rebated Applications

- Interior and exterior use
- Square back, squared front
- Ribbed aluminium insert



**Specifications**

**Length**  
5850mm (Cut-to-length service available)  
**Application**  
Rebated - Timber / Tile

**Insert Colours**



**Aluminium Colours**

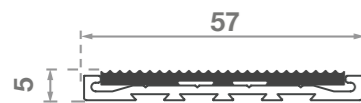
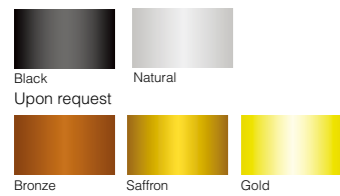

**Classic Tredfx**

**IKB439**

Aluminium Safety Stair Nosing for Rebated Applications

- Interior and exterior use
- Square back, square front
- Grit insert



**Specifications**

**Length**  
5850mm (Cut-to-length service available)  
**Application**  
Rebated - Timber / Tile

**Insert Colours**



**Classic Tredfx**

**IBB140**

Aluminium Safety Stair Nosing for Rebated Applications

- Interior and exterior use
- Square back, short raked front
- Ribbed polymer insert



**Specifications**

**Length**  
5850mm (Cut-to-length service available)  
**Application**  
Rebated - Timber / Tile

**Insert Colours**



**Aluminium Colours**

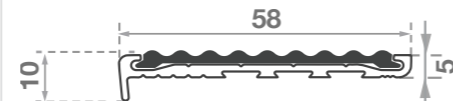

**Classic Tredfx**

**IKB140**

Aluminium Safety Stair Nosing for Rebated Applications

- Interior and exterior use
- Square back, short raked front
- Grit insert



**Specifications**

**Length**  
5850mm (Cut-to-length service available)  
**Application**  
Rebated - Timber / Tile

**Insert Colours**



**Aluminium Colours**

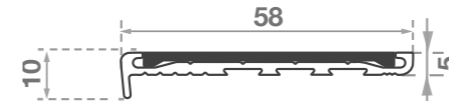

**Classic Tredfx**

**IKB440**

Aluminium Safety Stair Nosing for Rebated Applications

- Interior and exterior use
- Square back, short raked front
- Grit insert



**Specifications**

**Length**  
5850mm (Cut-to-length service available)  
**Application**  
Rebated - Timber / Tile

**Insert Colours**



**Aluminium Colours**



# Classic Tredfx Fibreglass

## Stair Nosings

- Fibreglass stair nosings
- Suitable for surface mount applications
- Ideal for industrial use
- Withstands extreme conditions
- Withstands high levels of moisture
- Resistant to most chemicals
- Non-conductive and fire resistant
- Highest P5 slip resistance rating
- Options for interior and exterior use
- LRV wet and dry ratings, pg. 90



**Classic Tredfx**  
**GKR030**  
Fibreglass Anti-Slip Stair Nosing  
for Surface Mount Applications

- Exterior use
- Ramped back, short square front
- Rugged anti-slip fibreglass



LRV Rating  
(pg 90)



P5 Slip  
resistance  
rating



Fire test  
report  
available



AS1428  
NCC  
Compliant

### Specifications

**Length**  
5850mm  
(Cut-to-length service available)

**Application**  
Surface Mount

### Nosing Colours



Black Yellow

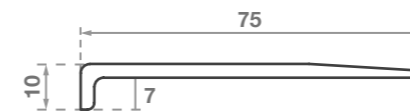

**Classic Tredfx**  
**GKR017**  
Fibreglass Anti-Slip Stair Nosing  
for Surface Mount Applications

- Exterior use
- Ramped back, square front
- Rugged anti-slip fibreglass



LRV Rating  
(pg 90)



P5 Slip  
resistance  
rating



Fire test  
report  
available

### Specifications

**Length**  
1200mm, 2400mm and 5850mm  
(Cut-to-length service available)

**Application**  
Surface Mount

### Nosing Colours



Black Yellow

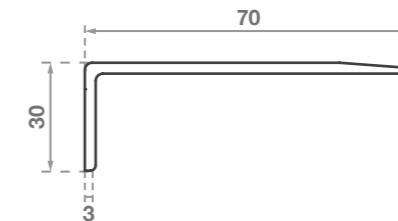

**Classic Tredfx**  
**TKR016**  
Traction Bar  
for Surface Mount Applications

- Interior and exterior use
- Ramped edges
- Slip-resistant grit
- Can also be used for stairs



LRV Rating  
(pg 90)



P5 Slip  
resistance  
rating



Fire test  
report  
available



AS1428  
NCC  
Compliant

### Specifications

**Length**  
1200mm, 2400mm and 5850mm  
(Cut-to-length service available)

**Application**  
Surface Mount

### Profile Colours



Black Yellow



**LIFETIME**  
WARRANTY

**INSTALLATION**  
SERVICES  
AVAILABLE

# Anti-Slip Tapes

## Stair Nosings

- Anti-slip tapes
- Self-adhesive for affordable and easy installation
- Ideal for access ramps
- Colours - black, yellow, clear and white
- Interior and exterior use
- Select a product with a slip resistant rating that suits your project's needs
- LRV wet and dry ratings, pg. 90



### 3M General Purpose Tape

Anti-Slip Self-Adhesive Tape

- Interior and exterior use
- Slip-resistant material
- Mineral coated
- Highly durable



#### Specifications

**Length**  
18.2 metres

**Width**  
25mm, 50mm, 100mm  
(other widths available on request)

**Application**  
Surface Mount

**Tape Colours**



### 3M Conformable Tape

Anti-Slip Self-Adhesive Tape

- Interior and exterior use
- Slip-resistant material
- Pliable aluminium backing
- Suits irregular surfaces



#### Specifications

**Length**  
18.2 metres

**Width**  
50mm, 100mm  
(other widths available on request)

**Application**  
Uneven Surfaces

**Tape Colours**



### Classic Tredfx Grit Tape

Anti-Slip Self-Adhesive Tape

- Interior and exterior use
- Slip-resistant material
- Mineral coated
- Self adhesive



#### Specifications

**Length**  
20 metres

**Width**  
50mm

**Application**  
Surface Mount

**Tape Colours**



# Accessories

## Stair Nosings

- Accessories for stair nosings
- Adhesive options to assist with easy installation
- Suitable for Classic Tredfx stair nosings



**3M**

### Spray Adhesive 77

Adhesive Spray

- Multi-purpose and fast drying adhesive

#### Benefits

Helps to prepare porous surfaces before application of 3M Safety-Walk Slip-Resistant tapes.

#### Application

For 3M Safety-Walk tape products.

#### Size

467g spray can



Caulking Gun Available

**Classic Tredfx**

### CA290 Adhesive

Instant Grab Construction Adhesive

- Excellent adhesion on almost all types of surfaces
- High abrasion and tear strength
- UV, water (salt and fresh) and weather resistant
- Instant grab

#### Benefits

Instant grab characteristics. High durability with good weathering and water resistance. Ready for immediate use in 290ml cartridge. Works on almost all surfaces.

#### Application

Can be applied to almost any surface. Always test prior to application. Not recommended for application on PE, PP, PC, PMMA, PTFE, Neoprene, Teflon, bituminous surfaces, or for continual water immersion and expansion joints. Great for interior and exterior applications for building and industry situations.

It is advised that CA290 is applied with a heavy-duty applicator gun. CA290 must be applied in volumes relating to material surface and weight of object, through large V shaped nozzles (as supplied). Apply in triangular beads, approximately 20 mm apart, then press the 2 materials together firmly so that the thickness is no thinner than 3mm. CA290 should not be applied in dots. If applied correctly no support is required during curing.

#### Size

290ml

# STAIR NOSING LRV Guide

## What is luminance contrast testing?

Luminance contrast is a measure that compares the luminance reflectance of two different surfaces. Reports are produced from information collected on site, to document the compliance/non-compliance to building standards.

## Luminescent Test Results

All values shown were measured in accordance with the requirements of AS/NZS 1428.4.1:2009 & AS1428.1-2009 using a Konica Minolta Chroma meter CR-400/410 with a diffuse illumination/normal viewing (d/o) geometry and CIE D65 illuminant. The products were tested in multiple locations, and results have been averaged out, and rounded up to the nearest whole decimal. This data should be used as a guide only.

Need luminance contrast testing on your project?  
**Contact Classic now for advice.**

### POLYMER INSERTS

Colour	Dry	Wet
Black	4.1	3.5
Blue	8.7	7.5
Dark Grey	6.5	6.1
Red	17.8	16.6
Tangerine	24.6	23.5
Mid Grey	24.4	23.9
Yellow	57.0	56.7
Beige	51.6	50.1
Light Grey	45.4	44.7
White	74.9	74.2
Ultra Violet	20.1	19.6
Raspberry	22.1	22.0
Teal	23.6	23.1
Lime Green	35.4	35.3
Coral	34.0	34.0

### GRIT INSERTS

Colour	Dry	Wet
Black	4.8	2.3
Yellow	51.0	48.3
Light Grey	55.3	52.0
Luminescent	39.3	38.0

### ALUMINIUM INSERTS

Colour	Dry	Wet
Black	3.4	2.3
Natural	54.8	53.5
Bronze	8.2	7.5
Saffron	42.1	38.4
Gold	49.8	45.4
Platinum	58.2	52.1

### SOLID BRASS NOSING

Colour	Dry	Wet
Natural Brass	51.8	43.5

### FIBREGLASS NOSING

Colour	Dry	Wet
Black	4.6	4.0
Yellow	40.1	38.5

### ANTI-SLIP TAPES

Colour	Dry	Wet
<b>3M GENERAL PURPOSE TAPE</b>		
Black	5.1	3.4
Yellow	50.3	43.9
Grey	17.3	17.0
<b>3M CONFORMABLE TAPE</b>		
Black	5.9	3.4
Yellow	50.3	43.9
<b>GRIT TAPE</b>		
Black	5.1	3.4
Yellow	50.3	43.9
Grey	17.3	17.0
White	82.3	88.8



# TACTILE INDICATORS

## Solid Brass



- Solid brass individual tactile indicators
- Naturally beautiful aesthetic
- Ages gracefully
- Ideal for retrofitting
- Expansive range that includes self-adhesive options
- Interior and exterior use
- Select a product with a slip resistant rating that suits your project's needs
- Complete the look with our solid brass stair nosings, pg. 58
- Looking for skate deterrents? Shop our Skatestop solid brass range, pg. 164

## Aluminium



- Aluminium individual tactile indicators
- Affordable
- Interior use
- Select a product with a slip resistant rating that suits your project's needs

## Ceramic



- Ceramic tactile indicators
- Warning and directional tactile tile formats
- UV stabilised
- Permanent inlaid solution
- Interior and exterior use
- Select a product with a slip resistant rating that suits your project's needs

## WHY CHOOSE CLASSIC?

- Consultative approach
- Customised solutions
- End-to-end fulfilment
- Unrivalled knowledge of standards
- Lifetime warranty
- Over 40 years' experience
- People and operations across Australia

## Stainless Steel

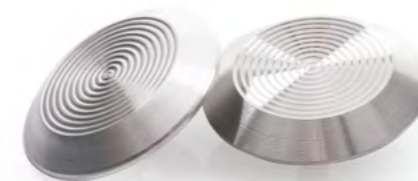

- Stainless steel tactile indicators
- Most popular
- Long lasting
- Ideal for retrofitting
- Expansive range - individual tactiles, directional bars and warning tactile plates
- Self-adhesive options
- Interior and exterior use
- Select a product with a slip resistant rating that suits your project's needs

## Polyurethane



- Polyurethane tactile indicators
- Ultimate solution for unique or creative designs
- UV resistant
- Expansive range - individual tactiles, warning and directional tactile tiles
- Peel and stick options for easy installation
- Large range of colours to suit all aesthetics
- Interior and exterior use
- Select a product with a slip resistant rating that suits your project's needs

## Accessories

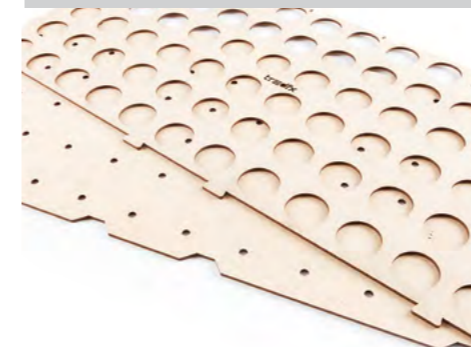

- Accessories for tactile indicators
- Layout templates to assist with easy installation
- Installation instructions available
- Suitable for Classic Tredfx tactile indicators

# Classic Tredfx Solid Brass

## Tactile Indicators

- Solid brass individual tactile indicators
- Naturally beautiful aesthetic
- Ages gracefully
- Ideal for retrofitting
- Expansive range that includes self-adhesive options
- Interior and exterior use
- Select a product with a slip resistant rating that suits your project's needs
- LRV wet and dry ratings, pg. 117
- Complete the look with our solid brass stair nosings, pg. 58
- Looking for skate deterrents? Shop our Skatestop solid brass range, pg. 164

**LIFETIME  
WARRANTY**

**INSTALLATION  
SERVICES  
AVAILABLE**

**NCC  
COMPLIANT**

**AS1428  
COMPLIANT**



### Classic Tredfx

## BH10N

Solid Brass TGS  
Individual Tactile

- Grooved 10 ring top
- Rear nylon stud
- Sloped sides for safe transition

### Application

Interior and exterior

### Tactile Colours



Natural Brass



LRV Rating  
(pg 118)



P5 Slip  
resistance  
rating



Fire  
Resistant

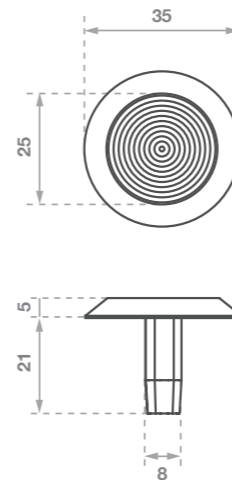

### Classic Tredfx

## BH10P

Solid Brass TGS  
Individual Tactile

- Grooved 10 ring top
- Plain sides
- Rear stud
- Sloped sides for safe transition

### Application

Interior and exterior

### Tactile Colours



Natural Brass



LRV Rating  
(pg 118)



P5 Slip  
resistance  
rating



Fire  
Resistant

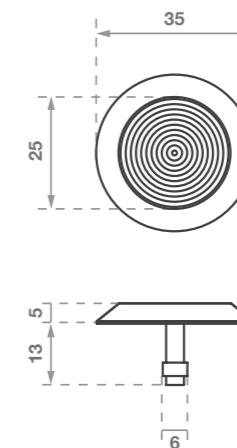

### Classic Tredfx

## BH10FA

Solid Brass TGS  
Individual Tactile

- Grooved 10 ring top
- Plain sides
- Without rear stud
- Sloped sides for safe transition
- Self-adhesive

### Application

Interior and exterior

### Tactile Colours



Natural Brass



LRV Rating  
(pg 118)



P5 Slip  
resistance  
rating



Fire  
Resistant

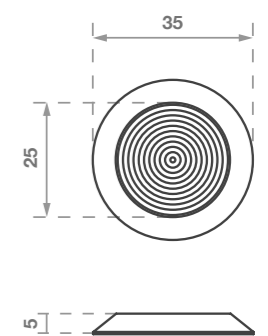





**Classic Tredfx**  
**BH60N**

Solid Brass TGS  
Individual Tactile

- Anti-slip with grit insert
- Plain sides
- Rear nylon stud
- Sloped sides for safe transition

**Application**

Interior and exterior

**Tactile Colours**



Natural Brass

**Insert Colours**



Black  
Upon Request



White



LRV Rating  
(pg 118)



P5 Slip  
resistance  
rating



Fire test  
report  
available

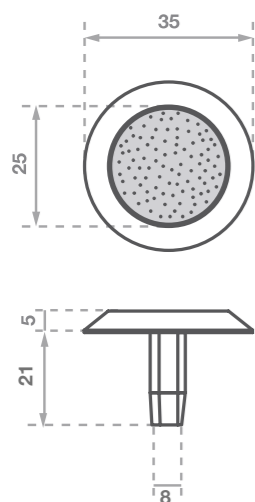

**Classic Tredfx**  
**BH60P**

Solid Brass TGS  
Individual Tactile

- Anti-slip with grit insert
- Plain sides
- Rear stud
- Sloped sides for safe transition

**Application**

Interior and exterior

**Tactile Colours**



Natural Brass

**Insert Colours**



Black  
Upon Request



White



LRV Rating  
(pg 118)



P5 Slip  
resistance  
rating



Fire test  
report  
available

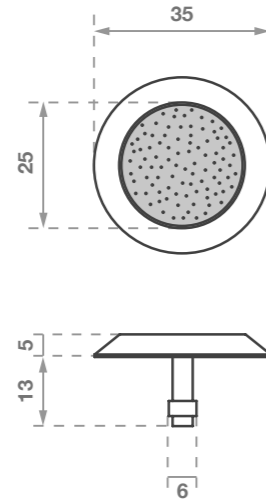

**Classic Tredfx**  
**BH60FA**

Solid Brass TGS  
Individual Tactile

- Anti-slip with grit insert
- Plain sides
- Without rear stud
- Sloped sides for safe transition
- Self-adhesive

**Application**

Interior and exterior

**Tactile Colours**



Natural Brass

**Insert Colours**



Black  
Upon Request



White



LRV Rating  
(pg 118)



P5 Slip  
resistance  
rating



Fire test  
report  
available

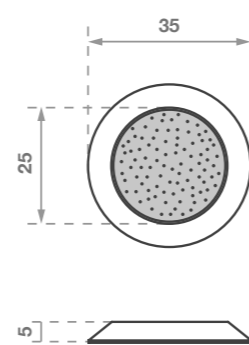

## Classic Tredfx

# Stainless Steel

### Tactile Indicators

- Stainless steel tactile indicators
- Most popular
- Long lasting
- Ideal for retrofitting
- Expansive range - individual tactiles, directional bars and warning tactile plates
- Self-adhesive options
- Interior and exterior use
- Select a product with a slip resistant rating that suits your project's needs
- LRV wet and dry ratings, pg. 117

**LIFETIME**  
WARRANTY

**INSTALLATION**  
SERVICES  
AVAILABLE

**NCC**  
COMPLIANT

**AS1428**  
COMPLIANT



### Classic Tredfx

## SH10N-B

Stainless Steel TGSI  
Individual Tactile

- Grooved 10 ring top
- Plain sides
- Rear nylon stud
- Sloped sides for safe transition
- T316 grade stainless steel with PVD treatment

#### Application

Interior and exterior

#### Tactile Colours



Black PVD



LRV Rating  
(pg 118)



P5 Slip  
resistance  
rating



Fire  
Resistant

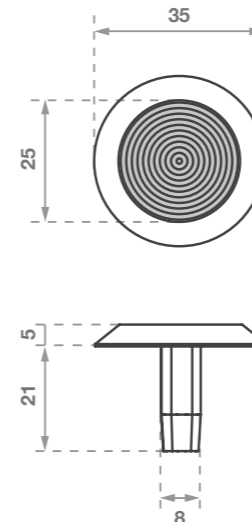

### Classic Tredfx

## SH10P-B

Stainless Steel TGSI  
Individual Tactile

- Grooved 10 ring top
- Plain sides
- Rear stud
- Sloped sides for safe transition
- T316 grade stainless steel with PVD treatment

#### Application

Interior and exterior

#### Tactile Colours



Black PVD



LRV Rating  
(pg 118)



P5 Slip  
resistance  
rating



Fire  
Resistant

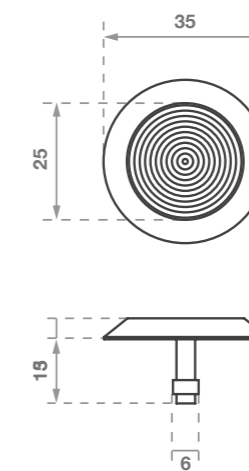

### Classic Tredfx

## SH10FA-B

Stainless Steel TGSI  
Individual Tactile

- Grooved 10 ring top
- Plain sides
- Without rear stud
- Sloped sides for safe transition
- T316 grade stainless steel with PVD treatment
- Self-adhesive

#### Application

Interior and exterior

#### Tactile Colours



Black PVD



LRV Rating  
(pg 118)



P5 Slip  
resistance  
rating



Fire  
Resistant

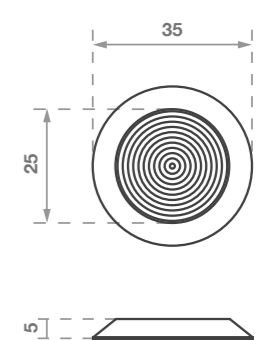



**Classic Tredfx**  
**SH10N**  
Stainless Steel TGSi  
Individual Tactile

**Classic Tredfx**  
**SH10P**  
Stainless Steel TGSi  
Individual Tactile

**Classic Tredfx**  
**SH10FA**  
Stainless Steel TGSi  
Individual Tactile

**Classic Tredfx**  
**SH10C**  
Stainless Steel TGSi  
with Fixing Screw

**Classic Tredfx**  
**SH60N**  
Stainless Steel TGSi  
with Grit Insert

**Classic Tredfx**  
**SH60P**  
Stainless Steel TGSi  
with Grit Insert

- Grooved 10 ring top
- Plain sides
- Rear nylon stud
- Sloped sides for safe transition
- T316 grade stainless steel

- Grooved 10 ring top
- Plain sides
- Rear stud
- Sloped sides for safe transition
- T316 grade stainless steel

- Grooved 10 ring top
- Plain sides
- Without rear stud
- Sloped sides for safe transition
- T316 grade stainless steel
- Self-adhesive

- Grooved 10 ring style top
- Plain sides
- Countersunk hole with stainless steel screw
- Sloped sides for safe transition
- T316 grade stainless steel

- Anti-slip with grit insert
- Plain sides
- Rear nylon stud
- Sloped sides for safe transition
- T316 grade stainless steel

- Anti-slip with grit insert
- Rear stud
- Sloped sides for safe transition
- T316 grade stainless steel

**Application**  
Interior and exterior

**Application**  
Interior and exterior

**Application**  
Interior and exterior

**Application**  
Interior and exterior

**Application**  
Interior and exterior

**Application**  
Interior and exterior

**Tactile Colours**



**Tactile Colours**



**Tactile Colours**



**Tactile Colours**



**Tactile Colours**



**Tactile Colours**



**Insert Colours**

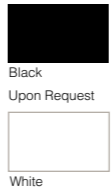

**Insert Colours**

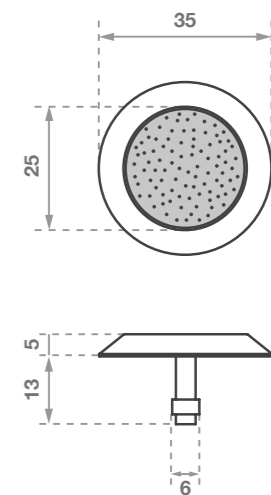
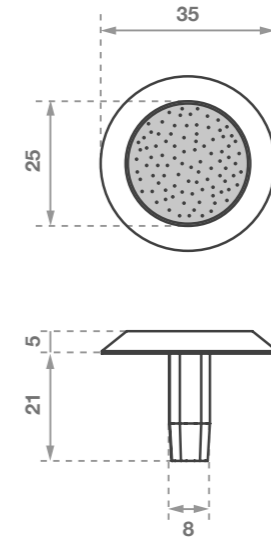
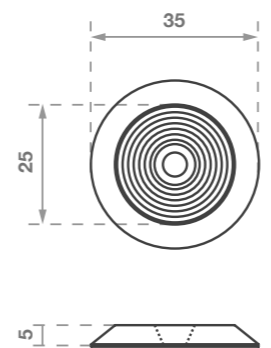
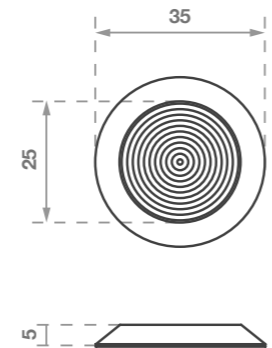
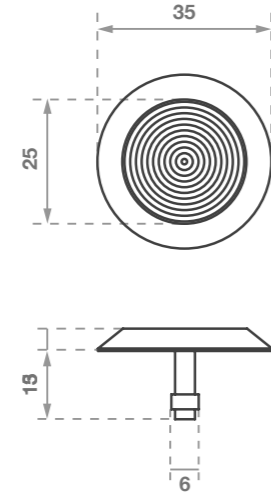
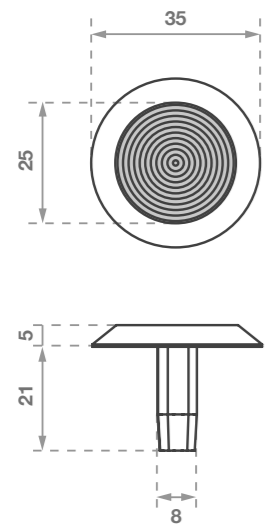
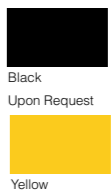



**Classic Tredfx**  
**SH60FA**

Stainless Steel TGSi with Grit Insert

- Anti-slip with grit insert
- Plain sides
- Without rear stud
- Sloped sides for safe transition
- T316 grade stainless steel
- Self-adhesive

**Application**  
Interior and exterior

**Tactile Colours**



Stainless Steel

**Insert Colours**



Black

Upon Request



Yellow



LRV Rating (pg 118)



P5 Slip resistance rating



Fire test report available

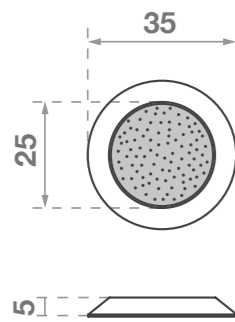

**Classic Tredfx**  
**SH75N**

Stainless Steel TGSi with Polyurethane Insert

- Grooved 10 ring polyurethane insert
- Plain sides
- Rear nylon stud
- Sloped sides for safe transition
- T316 grade stainless steel

**Application**  
Interior and exterior

**Tactile Colours**



Stainless Steel

**Insert Colours**



Black



Yellow



White



LRV Rating (pg 118)



P5 Slip resistance rating

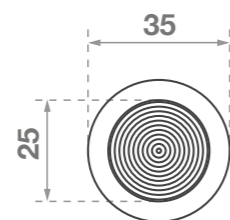

**Classic Tredfx**  
**SD19P**

Stainless Steel TGSi Directional Bar

- Grooved top
- Rear studs
- Sloped sides for safe transition
- T316 grade stainless steel

**Application**  
Interior and exterior

**Tactile Colours**



Stainless Steel



LRV Rating (pg 118)



P5 Slip resistance rating



Fire Resistant

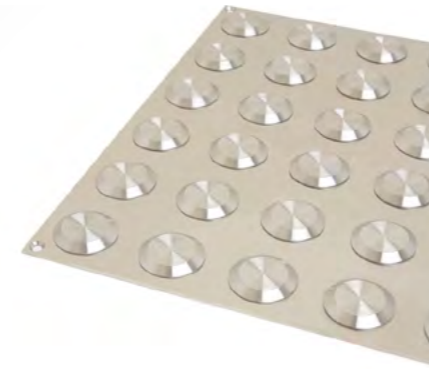
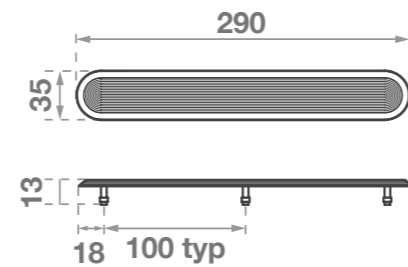

**Classic Tredfx**  
**SH10 Plate**

Stainless Steel TGSi Warning Tactile Plate Format

- Grooved 10 ring top
- Retro-fit application plate
- Increased strength

**Application**  
Interior and exterior

**Tactile Colours**



Stainless Steel



LRV Rating (pg 118)



P5 Slip resistance rating



Fire Resistant

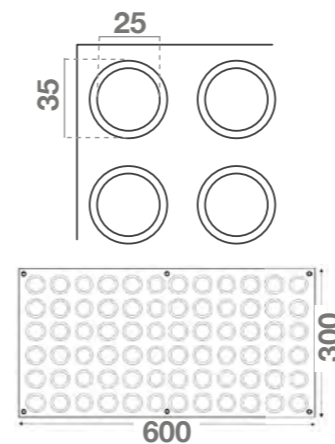

**Classic Tredfx**  
**SH60 Plate**

Stainless Steel TGSi Anti-Slip Warning Tactile Plate Format

- Anti-slip grit top
- Retro-fit application plate
- Increased strength

**Application**  
Interior and exterior

**Tactile Colours**

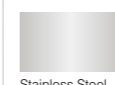

Stainless Steel

**Insert Colours**



Black



LRV Rating (pg 118)



P5 Slip resistance rating



Fire test report available

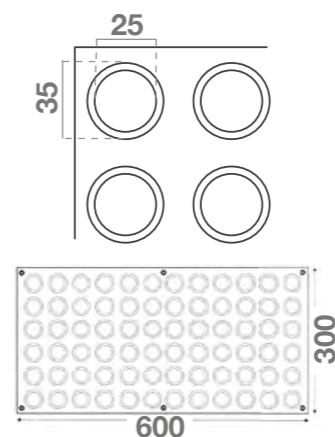

## Classic Tredfx

# Aluminium

### Tactile Indicators

- Aluminium individual tactile indicators
- Affordable
- Interior use
- Select a product with a slip resistant rating that suits your project's needs
- LRV wet and dry ratings, pg. 117

**LIFETIME**  
WARRANTY

**INSTALLATION**  
SERVICES  
AVAILABLE

**NCC**  
COMPLIANT

**AS1428**  
COMPLIANT



### Classic Tredfx

## AH10N

Aluminium TGSI  
Individual Tactile

- Grooved 10 ring top only
- Rear nylon stud
- Sloped sides for safe transition

### Application

Interior

### Tactile Colours



Silver

Upon request



Bronze



LRV Rating  
(pg 118)



P4 Slip  
resistance  
rating



Fire  
Resistant

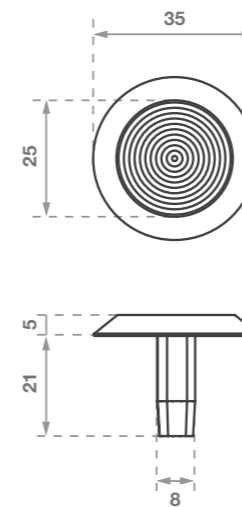

# Classic Tredfx

# Polyurethane

## Tactile Indicators

- Polyurethane tactile indicators
- Ultimate solution for unique or creative designs
- UV resistant
- Expansive range - individual tactiles, warning and directional tactile tiles
- Peel and stick options for easy installation
- Large range of colours to suit all aesthetics
- Interior and exterior use
- Select a product with a slip resistant rating that suits your project's needs
- LRV wet and dry ratings, pg. 117

**LIFETIME**  
WARRANTY

**INSTALLATION**  
SERVICES  
AVAILABLE

**NCC**  
COMPLIANT

**AS1428**  
COMPLIANT



### Classic Tredfx

## PH06P

Polyurethane TGSi  
Individual Tactile

- Grooved 6 ring top
- Plain sides
- Rear stud
- Sloped sides for safe transition

### Application

Interior and exterior

### Tactile Colours

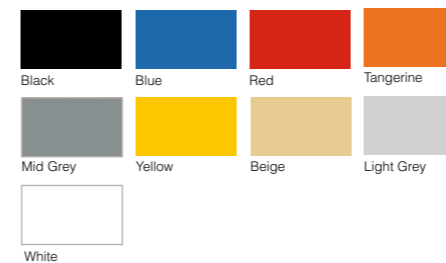

LRV Rating  
(pg 118)



P5 Slip  
resistance  
rating



Fire test  
report  
available

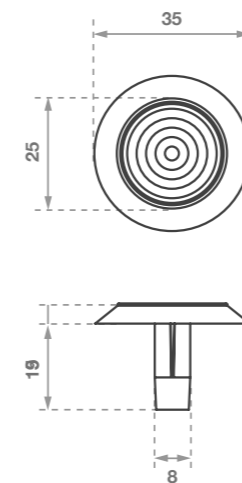

### Classic Tredfx

## PT30

Polyurethane TGSi  
Warning Tactile Tile Format

- Grooved 6 ring top
- 300mm x 300mm
- Bevelled edge for safe transition
- UV resistant polyurethane material

### Application

Interior and exterior

### Tactile Colours

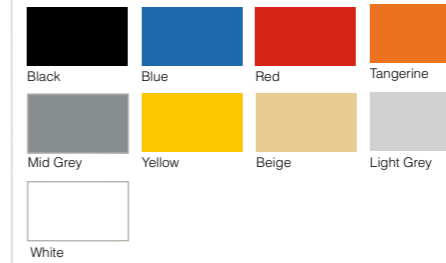

LRV Rating  
(pg 118)



P5 Slip  
resistance  
rating



Fire test  
report  
available

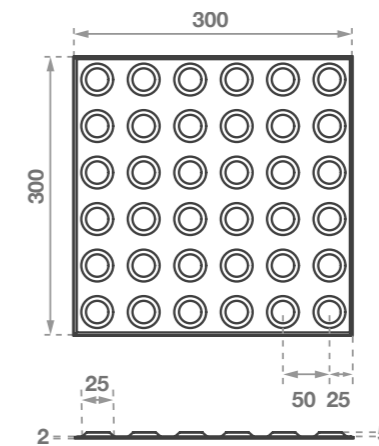

### Classic Tredfx

## PT30A

Polyurethane TGSi Peel and  
Stick Warning Tactile Tile Format

- Grooved 6 ring top
- 300mm x 300mm
- Peel and stick self-adhesive backing
- Bevelled edge for safe transition
- UV resistant polyurethane material

### Application

Interior and exterior

### Tactile Colours

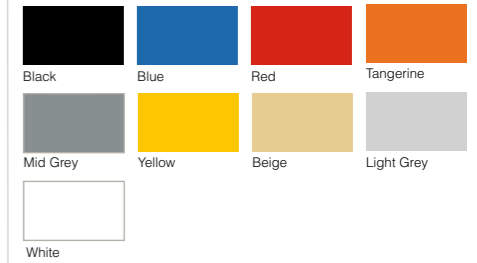

LRV Rating  
(pg 118)



P5 Slip  
resistance  
rating



Fire test  
report  
available

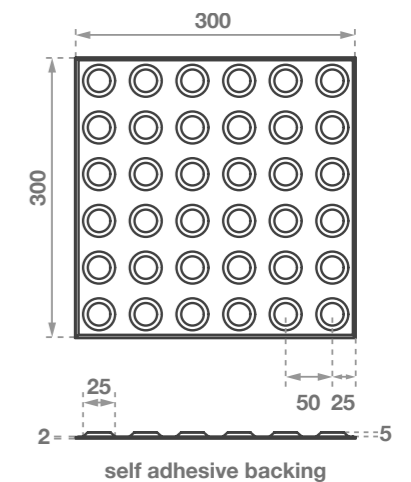



### Classic Tredfx

## PT39

Polyurethane TGS1  
Directional Tactile Tile Format

- Non-slip top
- 300mm x 150mm
- Bevelled edge for safe transition
- UV resistant polyurethane material

### Application

Interior and exterior

### Tactile Colours

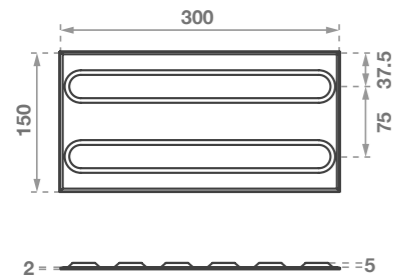

### Classic Tredfx

## PT39A

Polyurethane TGS1 Peel and Stick  
Directional Tactile Tile Format

- Non-slip top
- 300mm x 150mm
- Peel and stick self-adhesive backing
- Bevelled edge for safe transition
- UV resistant polyurethane material

### Application

Interior and exterior

### Tactile Colours

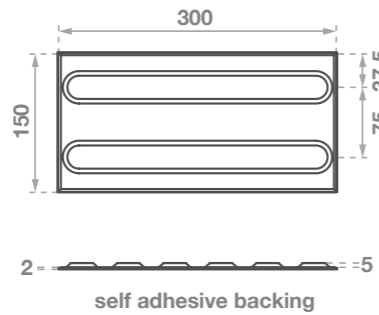

# Classic Tredfx

# Ceramic

## Tactile Indicators

- Ceramic tactile indicators
- Warning and directional tactile tile formats
- UV stabilised
- Permanent inlaid solution
- Interior and exterior use
- Select a product with a slip resistant rating that suits your project's needs
- LRV wet and dry ratings, pg. 117

**LIFETIME**  
WARRANTY

**INSTALLATION**  
SERVICES  
AVAILABLE

**NCC**  
COMPLIANT

**AS1428**  
COMPLIANT



### Classic Tredfx

## CH40

Ceramic TGS1  
Warning Tactile Tile Format

- Non-slip textured top
- UV stabilised
- For safe transportation sold in carton quantity multiples of 11

### Application

Interior and exterior

### Tactile Colours



LRV Rating  
(pg 118)



R12 Slip  
resistance  
rating



Fire  
Resistant

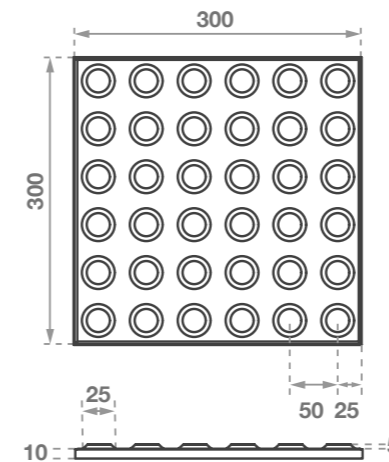

### Classic Tredfx

## CD49

Ceramic TGS1  
Directional Tactile Tile Format

- Non-slip textured top
- UV stabilised
- For safe transportation sold in carton quantity multiples of 11

### Application

Interior and exterior

### Tactile Colours



LRV Rating  
(pg 118)



R12 Slip  
resistance  
rating



Fire  
Resistant

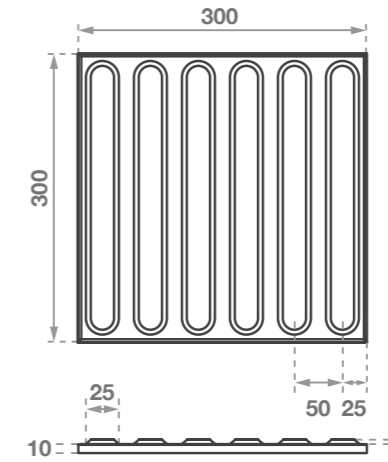



## Classic Tredfx

# Accessories

### Tactile Indicators

- Accessories for tactile indicators
- Layout templates to assist with easy installation
- Installation instructions available
- Suitable for Classic Tredfx tactile indicators

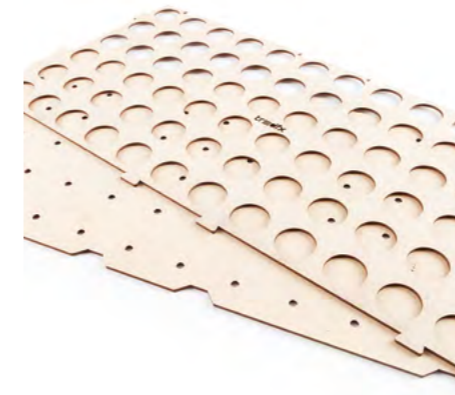

### Classic Tredfx Templates TGSI

Tactile Installation Layout  
Templates

Classic provides a range of installation templates to suit every tactile application. Their size and consistent layout, guides you to achieve the correct spacing for the installation of TGSI to the AS1428.4.1-2009.

- Provides a cost effective, simple and easy method of installation
- Unique interlocking modular panels allow tactile pads of any length by any width
- Easy to cut to suit site conditions where shaping around columns etc. may be required

#### Benefits

Designed to make your installation easy. Small and easy to move and lock together to suit the area required.

#### Application

Installation of tactile indicators to correct spacing in accordance with AS1428.4.1-2009 requirements.

#### Size

300mm x 600mm

# Colour Guide

This guide shows the specific colours available for each product across the Classic Tredfx Tactiles range. With a wide range of options to choose from, Classic can cater to many styles, design aesthetics and project needs. Our expert team will be delighted to assist, should you require any further advice or guidance on colour selection. Please note that these swatches are to remain as a guide and actual colours may vary.

## Individual Polyurethane

Individual Tactiles



Black



Blue



Red



Tangerine



Mid Grey



Yellow



Beige



Light Grey



White

## Tile Format Polyurethane

Tile Format



Black

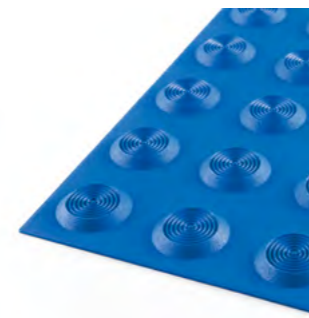

Blue



Red

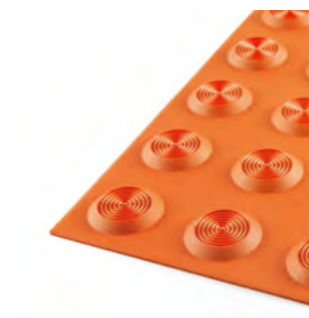

Tangerine



Mid Grey

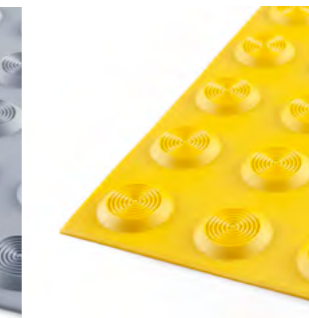

Yellow

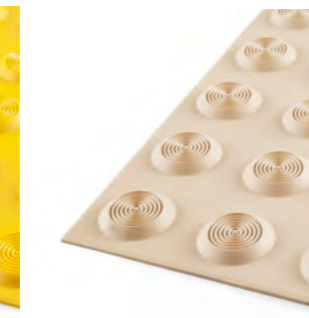

Beige



Light Grey



White

## Tile Format Ceramic

Tile Format



Charcoal



Ivory



Yellow

# TACTILE INDICATORS LRV Guide

### What is luminance contrast testing?

Luminance contrast is a measure that compares the luminance reflectance of two different surfaces. Reports are produced from information collected on site, to document the compliance/non-compliance to building standards.

### Luminescent Test Results

All values shown were measured in accordance with the requirements of AS/NZS 1428.4.1:2009 & AS1428.1-2009 using a Konica Minolta Chroma meter CR-400/410 with a diffuse illumination/normal viewing (d/o) geometry and CIE D65 illuminant. The products were tested in multiple locations, and results have been averaged out, and rounded up to the nearest whole decimal. This data should be used as a guide only.

### Luminescent Values – Tactile Indicators

Luminance contrast of Tactile Ground Surface Indicators (TGSIs) is the difference in the amount of light reflected from the TGSIs compared to the amount of light reflected from the base surface. Tactile tiles require a 30% luminance contrast; single colour Individual TGSIs require 45% LRC; and composite (dual colour) Individual TGSIs require 60% LRC. For further information refer to AS1428.4.1-2009.

### CLASSIC TREFDX SOLID BRASS TACTILES

Colours	Dry	Wet
Natural Brass	47.4	44.2

### CLASSIC TREFDX STAINLESS STEEL TACTILES

Colours	Dry	Wet
Stainless Steel	51	46.5
Stainless Steel - Black PVD	4.6	3.5
SH10C - Screw	51.0	46.5

### CLASSIC TREFDX POLYURETHANE / GRIT TACTILES

Colours	Dry	Wet
BH60N - Brass/Black	2.8	3.3
SH60N - Black	4.4	3.1
SH60N - White	52.2	51.4
SH60N - Yellow	36.9	36.4
SH75N - Black	3.0	2.7
SH75N -White	64.2	63.8
SH75N - Yellow	57.9	57.7

### CLASSIC TREFDX DIRECTIONAL TACTILES

Colours	Dry	Wet
Stainless Steel	38.3	32.1

### CLASSIC TREFDX ALUMINIUM TACTILES

Colours	Dry	Wet
Bronze	33.4	26.5
Silver	61.2	60.1

### CLASSIC TREFDX POLYURETHANE INDIVIDUAL TACTILES

Colour	Dry	Wet
Black	2.4	2.6
White	61.3	62.1
Blue	4.3	4.7
Red	8.5	9.2
Tangerine	25.4	25.7
Mid Grey	12.9	14.2
Yellow	49.0	48.8
Beige	33.5	34.7
Light Grey	47.8	47.7

### CLASSIC TREFDX POLYURETHANE TILE FORMAT TACTILES

Colours	Dry	Wet
Black	2.4	2.6
White	67.0	65.4
Blue	5.4	5.5
Red	12.5	12.2
Tangerine	24.7	24.9
Mid Grey	16.1	16.1
Yellow	41.3	42.2
Beige	29.8	30.2
Light Grey	43.2	43.3

### CLASSIC TREFDX CERAMIC TACTILES

Colours	Dry	Wet
Charcoal	9.9	7.7
Yellow	33.5	33.0
Ivory	44.7	44.0

## Classic Tredfx

# Expansion Joint Covers

- Engineered for commercial flooring applications
- Suits new or existing applications
- Foot safe for pedestrian traffic
- Allows horizontal substrate movement
- Suits variety of flooring - vinyl, tiled or concrete
- Pre-drilled and countersunk
- Supplied with fixings

**LIFETIME WARRANTY**

**INSTALLATION SERVICES AVAILABLE**

**NCC COMPLIANT**

**AS1428 COMPLIANT**



### Classic Tredfx

## EC2V

2 Part Expansion Square Edge for Vinyl Applications

The EC2V expansion joint cover is a two piece system that can be installed into vinyl or tiled floor finishes covering small expansion joints with a maximum gap of 10mm. Environments include: shopping and retail centres, schools, corridors and public buildings, indoor and outdoor public spaces.

- Suited well for retrofit applications
- Square edge to abut vinyl
- Pre-drilled and countersunk
- Supplied with fixings
- Foot safe for pedestrian traffic
- Allows horizontal substrate movement

**Length**  
3650mm

**Width**  
115 - 125mm (adjustable)

**Thickness**  
4mm O/A, 3mm edge

#### Colour



Aluminium



P3 Slip resistance rating



Fire Resistant

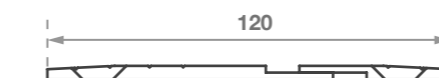

### Classic Tredfx

## EC2R

2 Part Expansion Ramp Edge for Timber / Concrete Applications

The EC2R expansion joint cover is a two piece system that can be installed onto vinyl, tiled or pre-finished concrete floors, covering small expansion joints with a maximum gap of 10mm. Environments include: shopping and retail centres, schools, corridors and public buildings, indoor and outdoor public spaces.

- Suited well for retrofit applications
- Ramped edge to 1mm
- Pre-drilled and countersunk
- Supplied with fixings
- Foot safe for pedestrian traffic
- Allows horizontal substrate movement

**Length**  
3650mm

**Width**  
130 - 140mm (adjustable)

**Thickness**  
4mm O/A, 1mm edge

#### Colour



Aluminium



P3 Slip resistance rating



Fire Resistant

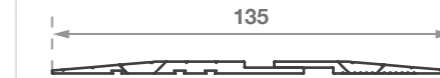

# Classic Tredfx

# Floor Trims

- Engineered for commercial flooring applications
- Designed for smooth transition between floor surfaces
- Concealed fixings, all fixings supplied
- Aluminium and stainless steel options
- Options for different flooring types
- Facilitate wheelchair access
- Pre-drilled and countersunk



**Classic Tredfx**  
**TRP33H**  
2 Part Trim with Aluminium Flat Top

- Elegant design, high strength, easy assembly and maximum load capacity
- Innovative flat clip profile system with aluminium top section and a base section made of impact-resistant polymer
- Simple, fast and reliable installation - problem free disassembly and re-usability
- Continuously variable adaptation of both the height and inclination
- Base and upper section are shrink wrapped together as a set
- High load capacity up to 1.5 tons

**Application**  
Connection trim between differing floor finishes to compensate for height differences of up to 3mm.

**Specifications**

<b>Length</b> 3650mm	<b>Height (A)</b> 6 - 12mm
<b>Top Width</b> 33mm	<b>Height (B)</b> 8 - 14mm
<b>Base Width</b> 25mm	
<b>Colour</b>  Aluminium	

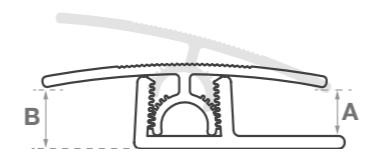

**Classic Tredfx**  
**TRP44R**  
2 Part Trim with Aluminium Ramp Top

- Elegant design, high strength, easy assembly and maximum load capacity
- Innovative ramped clip profile system with aluminium top section and a base section made of impact-resistant polymer
- Simple, fast and reliable installation - problem free disassembly and reusability
- Continuously variable adaptation of both the height and inclination
- Base and upper section are shrink wrapped together as a set
- High load capacity up to 1.5 tons

**Application**  
Connection trim between differing floor finishes to compensate for height differences of up to 3mm.

**Specifications**

<b>Length</b> 2700mm	<b>Height (A)</b> 0 - 12mm
<b>Top Width</b> 43mm	<b>Height (B)</b> 6 - 12mm
<b>Base Width</b> 25mm	
<b>Colour</b>  Aluminium	

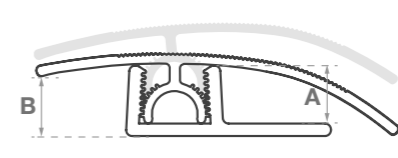

**Classic Tredfx**  
**CSA50**  
Aluminium Floor Cover Strip

- Solid design for commercial installations, but would also suit domestic applications
- Designed for smooth transition between different floor surfaces
- Concealed fixing with self adhesive aluminium strip
- Supplied complete with fixings

**Application**  
For transitions between floor finishes of different levels, to be installed over the top of the floor finish.

**Specifications**

<b>Length</b> 3650mm
<b>Width</b> 50mm
<b>Height</b> 5.5mm
<b>Colour</b>  Aluminium

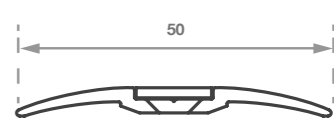

**LIFETIME WARRANTY**

**INSTALLATION SERVICES AVAILABLE**

**NCC COMPLIANT**

**AS1428 COMPLIANT**



### Classic Tredfx CSA75

Aluminium Floor  
Cover Strip

- Solid design for commercial installations, but would also suit domestic applications
- Designed for smooth transition between different floor surfaces
- Concealed fixing with self adhesive aluminium strip
- Supplied complete with fixings

#### Application

For transitions between floor finishes of different levels, to be installed over the top of the floor finish.

#### Specifications

**Length**  
3650mm

**Width**  
75mm

**Height**  
5.5mm

#### Colour



Aluminium



Fire  
Resistant

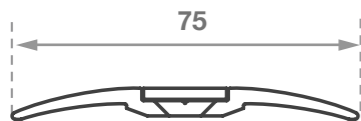

### Classic Tredfx FCS40

Stainless Steel Folded  
Cover Strip

Tredfx FCS series folded cover strips are used in applications as diverse as expansion covers and transitions between differing floor levels and surfaces.

- Easy installation
- Provides a perfect finished appearance
- Automatic adjustment for height and tilt
- Quick and safe installation
- Pre-drilled and countersunk

#### Application

For transitions between floor finishes of different levels, to be installed over the top of the floor finish.

#### Specifications

**Length**  
2400mm

**Width**  
40mm

**Height**  
5mm O/A

#### Colour



Satin Stainless Steel



Fire  
Resistant

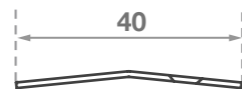

### Classic Tredfx FCS60

Stainless Steel Folded  
Cover Strip

Tredfx FCS series folded cover strips are used in applications as diverse as expansion covers and transitions between differing floor levels and surfaces.

- Easy installation
- Provides a perfect finished appearance
- Automatic adjustment for height and tilt
- Quick and safe installation
- Pre-drilled and countersunk

#### Application

For transitions between floor finishes of different levels, to be installed over the top of the floor finish.

#### Specifications

**Length**  
2400mm

**Width**  
60mm

**Height**  
5mm O/A

#### Colour



Satin Stainless Steel



Fire  
Resistant

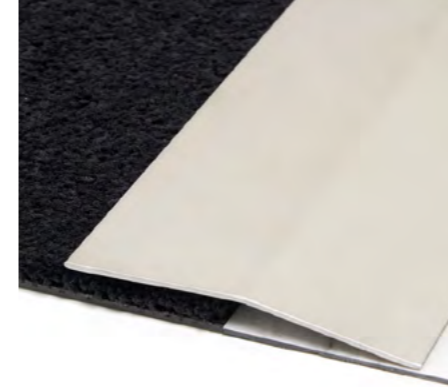
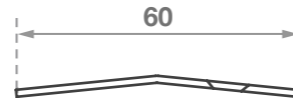

### Classic Tredfx FCS80

Stainless Steel Folded  
Cover Strip

Tredfx FCS series folded cover strips are used in applications as diverse as expansion covers and transitions between differing floor levels and surfaces.

- Easy installation
- Provides a perfect finished appearance
- Automatic adjustment for height and tilt
- Quick and safe installation
- Pre-drilled and countersunk

#### Application

For transitions between floor finishes of different levels, to be installed over the top of the floor finish.

#### Specifications

**Length**  
2400mm

**Width**  
80mm

**Height**  
5mm O/A

#### Colour



Satin Stainless Steel



Fire  
Resistant

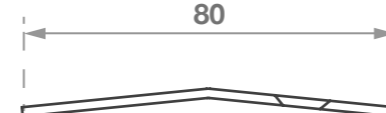

### Classic Tredfx FCS100

Stainless Steel Folded  
Cover Strip

Tredfx FCS series folded cover strips are used in applications as diverse as expansion covers and transitions between differing floor levels and surfaces.

- Easy installation
- Provides a perfect finished appearance
- Automatic adjustment for height and tilt
- Quick and safe installation
- Pre-drilled and countersunk

#### Application

For transitions between floor finishes of different levels, to be installed over the top of the floor finish.

#### Specifications

**Length**  
2400mm

**Width**  
100mm

**Height**  
5mm O/A

#### Colour



Satin Stainless Steel



Fire  
Resistant



### Classic Tredfx ETV3

Edge Trim, 3mm

- Edge trim for vinyl flooring
- Provides a solid and clean finish at horizontal and vertical junctions

#### Specifications

**Length**  
3300mm

**Size**  
3mm x 40mm x 26mm

**Edge**  
Trim, 3mm

#### Colour



Natural (clear anodised)



Fire  
Resistant

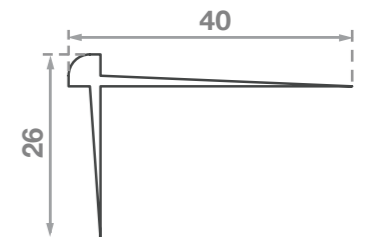

Floor Trims



**Classic Tredfx**  
**ETC6**

Edge Trim, 6mm

- Edge trim for carpet and tile
- Provides a solid and clean finish at horizontal and vertical junctions

**Specifications**

**Length**

3300mm

**Size**

6mm x 43mm x 34mm

**Edge**

Trim, 6mm

**Colour**



Natural (clear anodised)



Fire Resistant

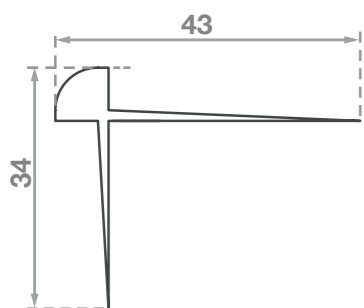

**Classic Tredfx**  
**Ramp Ezi**

Ramping Solution for Surface Mounted Mats

- Easy ramping solution
- Versatile
- Adapts to various ramp height options
- PVC

**Specifications**

**Width / Ramp Height Options**

- 300mm width with ramp height options - 7mm, 6mm, 5mm & 4mm

- 165mm width with ramp height options - 2.5mm, 2.0mm & 1.5mm

**Colour**



Black

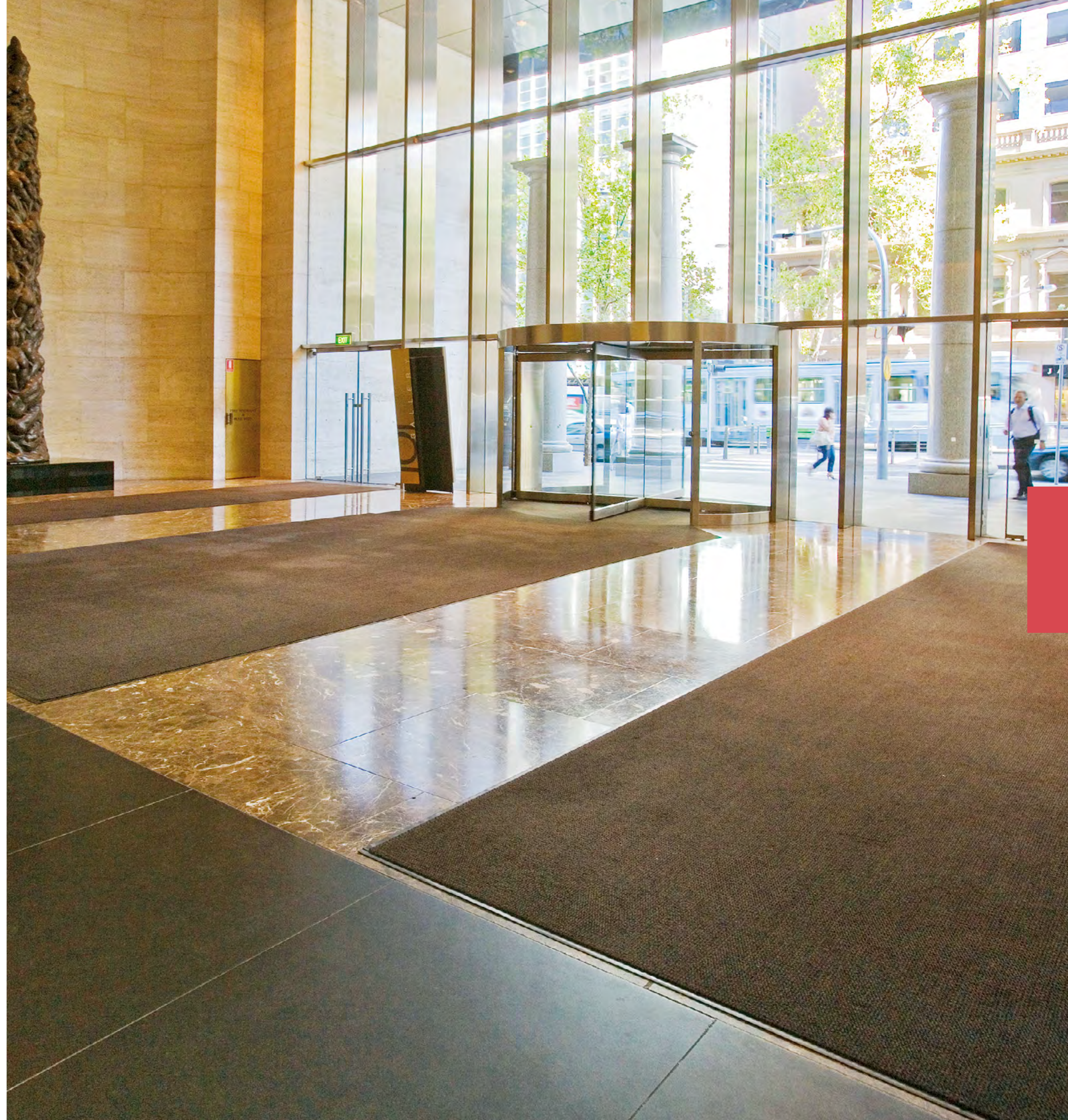
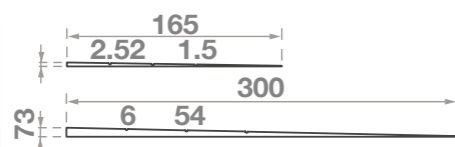

# CAR PARK SAFETY

## WHY CHOOSE CLASSIC?

- Consultative approach
- Customised solutions
- End-to-end fulfilment
- Unrivalled knowledge of standards
- Lifetime warranty
- Over 40 years' experience
- People and operations across Australia

### Bollards



- Designed for traffic control situations or property and asset protection
- Galvanised, yellow powder coated and stainless steel options
- Removable bollards come in key-lock and padlock options
- Collapsible bollard option
- Surface mount and cast in applications
- Quality appearance
- Variety of sizes

### Speed Humps



- Designed to slow speed for safety
- Economical rubber options
- Heavy duty steel options to slow up the heaviest of vehicles
- Built to withstand harsh conditions
- Highly visible with inbuilt reflectors

### Wheel Stops



- Designed to stop wheels, working as a boundary when parking a vehicle
- Practical and durable
- Concrete and rubber options
- Supplied with all fixings
- Easy to install

### Height Bars



- Designed to eliminate damage to vehicles and property caused by oversized vehicles entering areas of restricted height
- Yellow powder coated
- Different installation options available

### Corner Guards

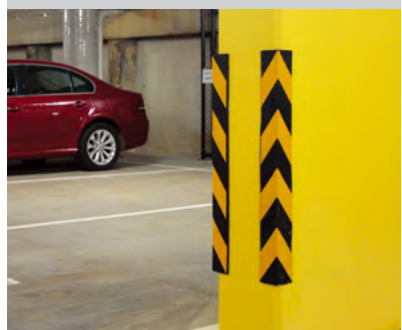

- Helps identify columns or obstruction in low light areas to prevent damage to vehicles and property
- Rubber, galvanised steel and stainless steel options
- Easy to install

### Safety Mirrors

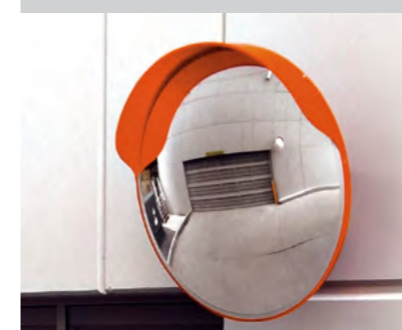

- Designed to give broader vision in blind spots which can pose a risk to motorists and pedestrians
- Unbreakable polycarbonate face
- Interior and exterior use
- Different installation options available

### Signage



- Car park and street signs utilised as a method of warning and guiding drivers and pedestrians
- Expansive range of signs and fixings



# Classic Bollards

- Designed for traffic control situations or property and asset protection
- Galvanised, yellow powder coated and stainless steel options
- Removable bollards come in key-lock and padlock options
- Collapsible bollard option
- Surface mount and cast in applications
- Quality appearance
- Variety of sizes



## Classic

# Stainless Steel Bollards

## Surface Mount

### Description

Classic stainless steel bollards have a welded cap. This helps present the high quality appearance required for architectural environments. These bollards are for surface mounting, supplied with a welded base plate and all fixings.

### Application

Surface mount

### Finish



Stainless steel  
T316 grade

Code	A length (mm)	B below surface length (mm)	C width (mm)	D wall thick (mm)	Stainless Steel grade	CAP	Baseplate (mm)
DB1412BS	1200	-	140	4-5	316SS	Welded	240Ø x 6
DB912BS	1200	-	90	4-5	316SS	Welded	190Ø x 6

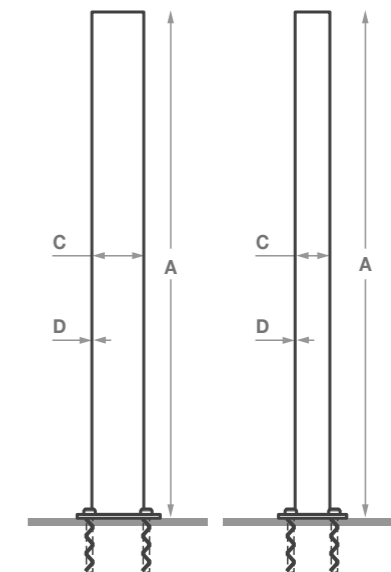

SURFACE MOUNT



**LIFETIME  
WARRANTY**

**INSTALLATION  
SERVICES  
AVAILABLE**

**NCC  
COMPLIANT**

**AS2890  
COMPLIANT**



## Classic Stainless Steel Bollards

### Cast In

#### Description

Classic stainless steel bollards have a welded cap. This helps present the high quality appearance required for architectural environments. These bollards are suitable for below ground installation into a suitable concrete footing.

#### Application

Cast in

#### Finish



Stainless steel  
T316 grade

Code	A length (mm)	B below surface length (mm)	C width (mm)	D wall thick (mm)	Stainless Steel grade	CAP	Baseplate (mm)
DB915CS	1200	300	90	4-5	316SS	Welded	-
DB1415CS	1200	300	140	4-5	316SS	Welded	-

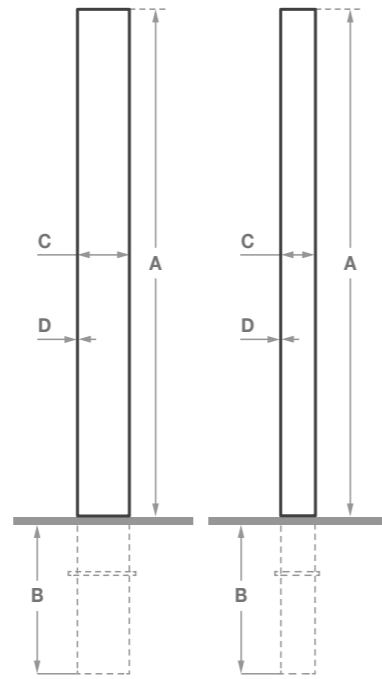

CAST IN

- Round profile
- Weather resistant
- Stainless steel
- Easy installation

LIFETIME WARRANTY

INSTALLATION SERVICES AVAILABLE

NCC COMPLIANT

AS2890 COMPLIANT



## Classic Powder Coated Bollards

### Surface Mount

#### Description

Classic fixed surface mount bollards are designed for traffic control situations or property and asset protection. Manufactured from heavy wall mild steel tube with fully welded base plates.

#### Application

Surface mount

#### Finish



Powder coated  
in safety yellow

Code	A length (mm)	B width (mm)	C wall thickness	No. of fixings	CAP	Base plate size (mm)	Finish
DB912BP	1200	90	5	4	Press Fit	190Ø x 6	PC
DB1412BP	1200	140	5	4	Press Fit	240Ø x 6	PC

PC = Powder Coated

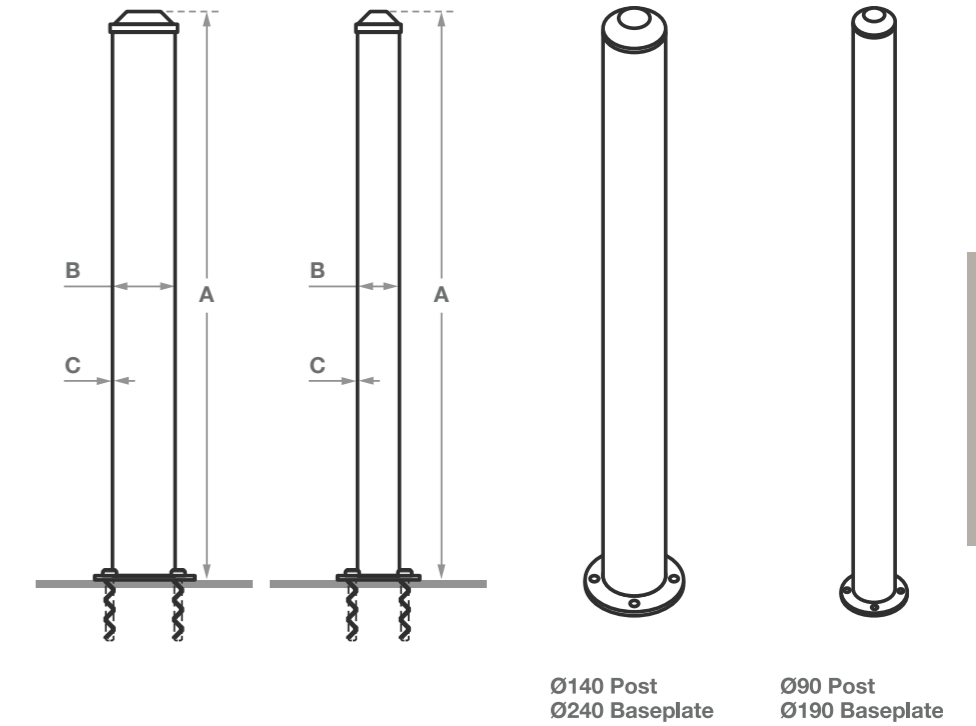

SURFACE MOUNT

- Round profile
- Weather resistant
- Powder coated
- Easy installation

LIFETIME WARRANTY

INSTALLATION SERVICES AVAILABLE

NCC COMPLIANT

AS2890 COMPLIANT



## Classic Powder Coated Bollards

### Cast In

#### Description

Classic cast in fixed bollards are designed for traffic control situations or property and asset protection. Manufactured from heavy wall mild steel tube. These bollards are suitable for below ground installation into a suitable concrete footing.

#### Application

Cast in

#### Finish



Powder coated in safety yellow

Code	A length (mm)	B below surface length (mm)	C width (mm)	D wall thickness (mm)	CAP	Finish
DB915CP	1200	300	90	5	Press Fit	PC
DB1415CP	1200	300	140	5	Press Fit	PC

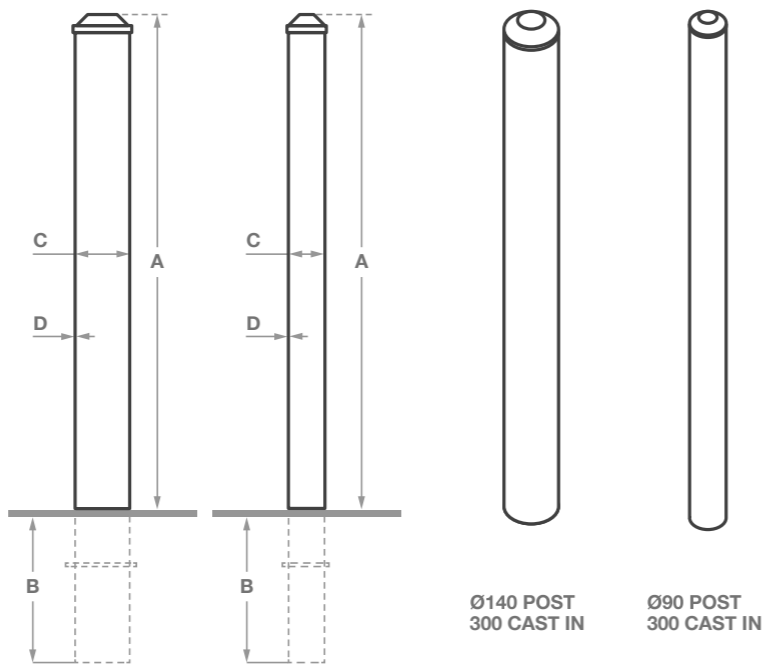

LIFETIME WARRANTY

INSTALLATION SERVICES AVAILABLE

NCC COMPLIANT

AS2890 COMPLIANT

- Round profile
- Weather resistant
- Powder coated
- Easy installation



## Classic Galvanised Bollards

### Surface Mount

#### Description

Classic fixed surface mount bollards are designed for traffic control situations or property and asset protection. Manufactured from heavy wall mild steel tube with fully welded base plates.

#### Application

Surface mount

#### Finish



Galvanised

Code	A length (mm)	B width (mm)	C wall thickness (mm)	No. of fixings	CAP	Base plate size (mm)	Finish
DB912BG	1200	90	5	4	Press Fit	190Ø x 6	Galvanised
DB1412BG	1200	140	5	4	Press Fit	240Ø x 6	Galvanised

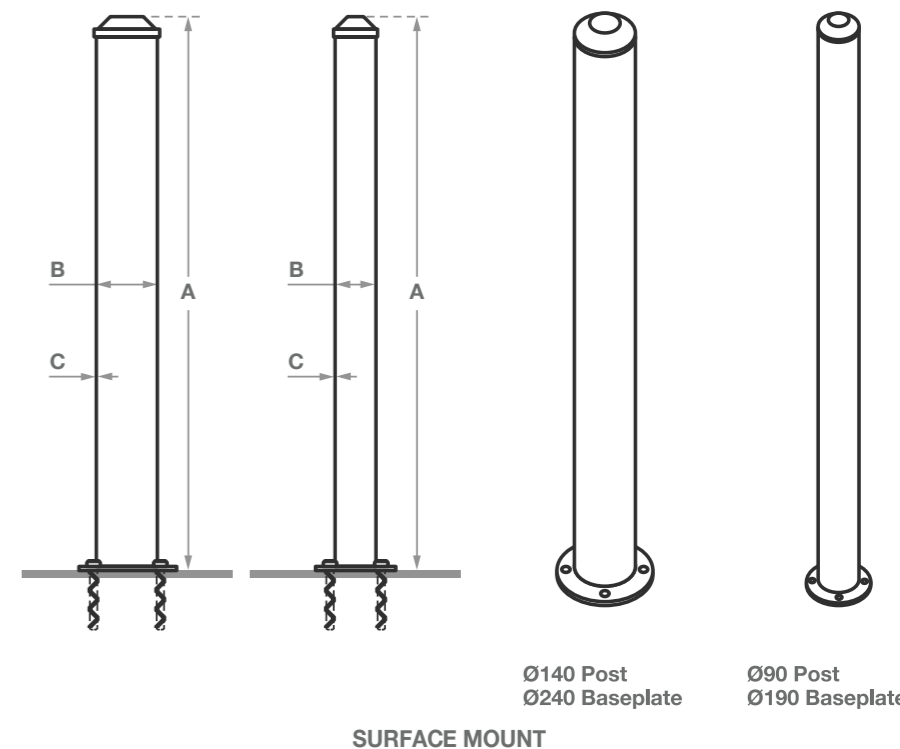

LIFETIME WARRANTY

INSTALLATION SERVICES AVAILABLE

NCC COMPLIANT

AS2890 COMPLIANT

- Round profile
- Weather resistant
- Galvanised steel
- Easy installation



# Classic Galvanised Bollards

Cast In

### Description

Classic cast in fixed bollards are designed for traffic control situations or property and asset protection. Manufactured from heavy wall mild steel tube. These bollards are suitable for below ground installation into a suitable concrete footing.

### Application

Cast in

Code	A length (mm)	B below surface length (mm)	C width (mm)	D wall thickness (mm)	CAP	Finish
DB915CG	1200	300	90	5	Press Fit	Gal
DB1415CG	1200	300	140	5	Press Fit	Gal

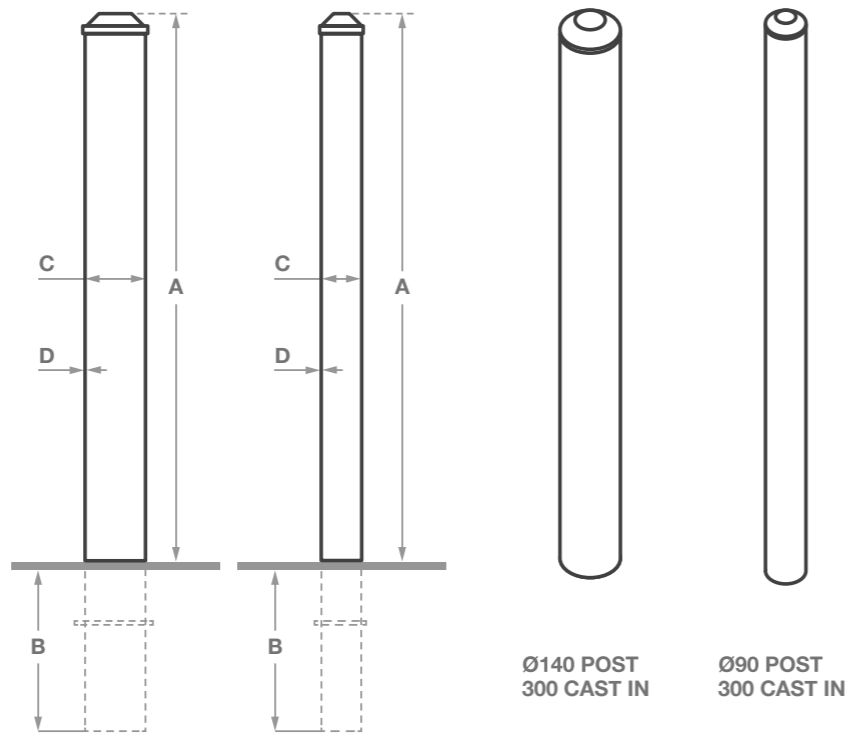

- Round profile
- Gal Galvanised steel
- Weather resistant
- Easy installation

### Finish



Galvanised

**LIFETIME WARRANTY**

**INSTALLATION SERVICES AVAILABLE**

**NCC COMPLIANT**

**AS2890 COMPLIANT**



# Classic Key-locking Removable Bollards

Powder Coated, Socket Mount

### Description

Classic key-locking and removable powder coated bollards are designed for protecting property and assets, whilst still allowing the flexibility of access control to restricted areas. Manufactured using heavy galvanised steel. Commonly used in car dealerships, warehouse premises and traffic control applications.

- 90mm post with 5mm wall thickness
- Post locks into an in-ground locking sleeve that can be cast into concrete or retro-fitted into an existing concrete slab
- Supplied with keyed lock

### Application

Removeable, socket mount

Code	A length (mm)	B width (mm)	C wall thickness (mm)	D below surface length (mm)
DB911RLP9	900	90	5	200

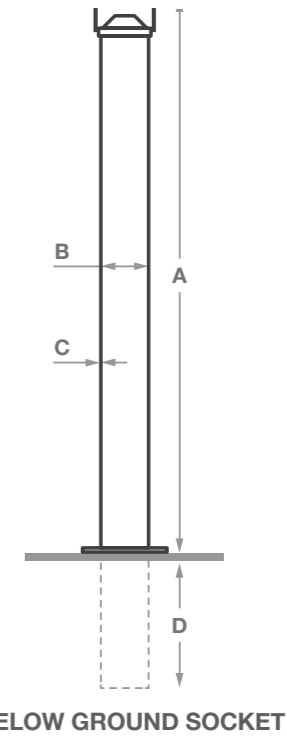

- Round profile
- Gal Galvanised steel
- Weather resistant
- Easy installation
- Removable
- Powder coated
- Key locking

### Finish

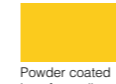

Powder coated in safety yellow

**LIFETIME WARRANTY**

**INSTALLATION SERVICES AVAILABLE**



## Classic Padlock Removable Bollards

Powder Coated, Socket Mount

### Description

The Classic construction bollard, padlock removable with square in-ground hinged locking sleeve, is designed for protecting property and assets, while still allowing the flexibility of access control to restricted areas. Manufactured using heavy galvanised steel. Commonly used in car dealerships, warehouse premises and traffic control applications.

- Padlock removable bollard with in-ground locking sleeve and hinged flap
- 90mm post with 4mm wall thickness
- Padlock not supplied

### Application

Removeable, socket mount with hinged lid

Code	A length (mm)	B width (mm)	C wall thickness (mm)	D below surface length (mm)
DB911RPP9	900	90	4	200

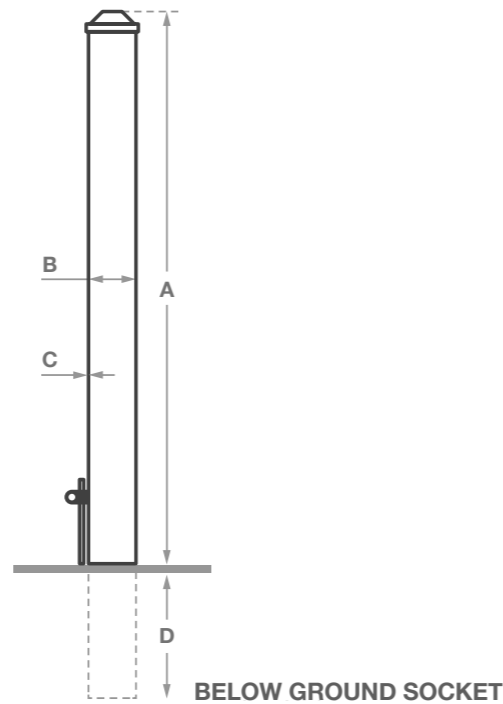

Round profile	Removable
Galvanised steel	Powder coated
Weather resistant	Post locking
Easy installation	

### Finish



**LIFETIME WARRANTY**

**INSTALLATION SERVICES AVAILABLE**



## Classic Collapsible Bollards

Surface Mount

### Description

The Classic collapsible bollard has been designed for vehicle access control and parking space protection. Also available as a surface mount model or can be used with an in-ground kit. Reflective sign face ordered separately.

- Stands 800mm tall when locked
- Flat on ground 80mm high
- Includes fixings and padlock
- Broad face of 150mm

### Application

Surface mount

### Fixing

Masonry anchors (supplied)

### Locking

Padlock (supplied)

### Material

Galvanised steel

### Finish



**LIFETIME WARRANTY**

**INSTALLATION SERVICES AVAILABLE**

Code	Description	A height up (mm)	B height down (mm)	C front width (mm)	D side width (mm)
DB5080FLPR	Fold down, key lockable bollard	800	80	150	50
15BBGK4	In-ground kit for DB5080 series	-	-	-	-

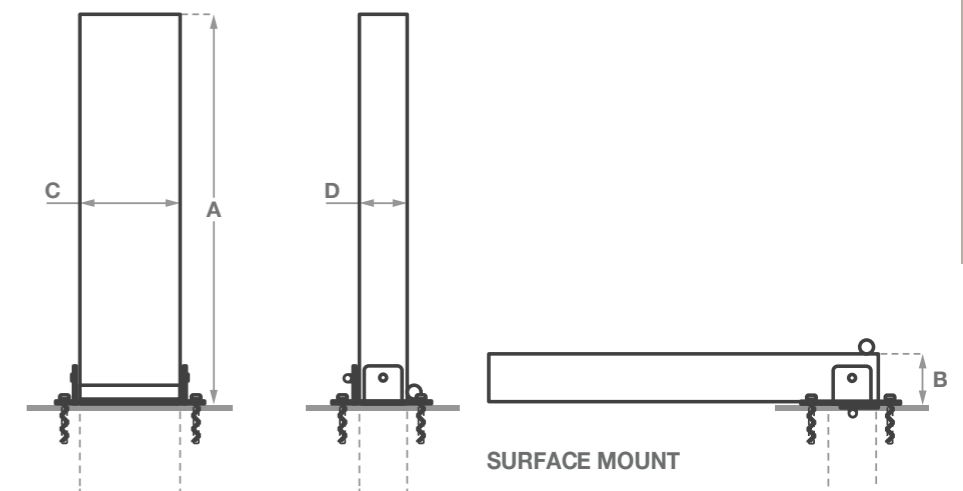

Galvanised steel	Easy installation
Weather resistant	Powder coated

Classic

# Speed Humps

- Designed to slow speed for safety
- Economical rubber options
- Heavy duty steel options to slow up the heaviest of vehicles
- Built to withstand harsh conditions
- Highly visible with inbuilt reflectors



Classic

## Speed Hump

Economy Rubber

### Description

Classic rubber speed humps are a great economical option. Speed humps are required to prevent speeding in areas where a slow speed is imperative. For example: schools, parks and secondary roads. Manufactured from sturdy recycled rubber, they are built to withstand harsh conditions and provide high visibility.

- Complies with AS2890.1-2004
- High traffic areas
- Interlocking sections to 'spread the load' across all the fixings
- Recessed fixing points
- Inbuilt reflectors
- Fixings are included

### Application

Bitumen or concrete

### Material

Recycled and natural rubber

### Length

500mm modules plus 250mm ends

### Colour



Black/Yellow stripes

Code	Description	A length (mm)	B height (mm)	C width (mm)	D length end cap (mm)
AH50R	Rubber speed hump	500	50	340	-
AH25RE-BLACK	Black rubber end cap	-	50	340	250
AH25RE-YELLOW	Yellow rubber end cap	-	50	340	250

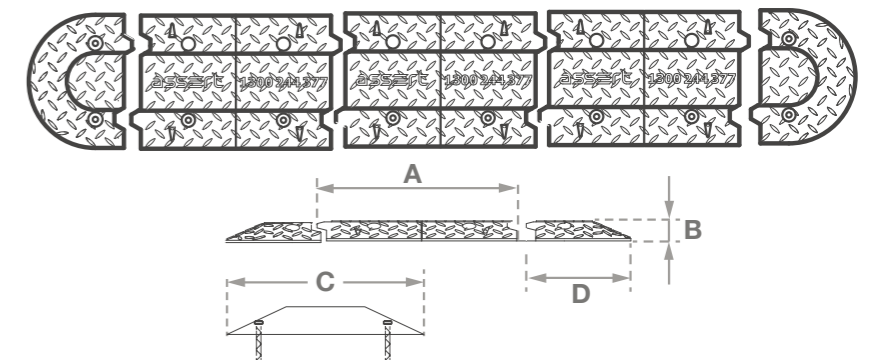

**LIFETIME WARRANTY**

**INSTALLATION SERVICES AVAILABLE**

**NCC COMPLIANT**

**AS2890 COMPLIANT**

Recycled rubber

Fast installation

Weather resistant

Checker plate non-slip surface



# Classic Speed Hump

## Heavy Duty Steel

### Description

Classic heavy duty steel speed humps are for heavy vehicle applications - including large trucks. Perfectly suited to transport depots, factories and terminals. The superior strong hassis construction along with 6mm floor plate and 6 bolt fixing makes the heavy duty steel speed hump virtually indestructible. It has more than 4 times the load bearing contact area with the road surface compared to conventional types. Designed to comply with AS2890.1-2004. These versatile speed humps can be used with or without end caps for slowing of heavy vehicles.

- Complies with AS2890.1-2004
- More than 4 times the load bearing contact area with the road surface than other speed humps
- Use with or without end caps
- Complete with all fixings
- Independent modules for easy removal
- Does not require a rubber underlay to prevent rattle
- Concealed fixings remain accessible
- Modules have a built-in bridge design to accommodate hoses and cables

### Application

Bitumen or concrete

### Length

1000mm, 500mm modules

### Material

Heavy duty steel

Code	Description	A length (mm)	B height (mm)	C width (mm)	D length end cap (mm)
AH100S	Steel heavy duty	1000	55	350	-
AH50S	Steel heavy duty	500	55	350	-
AHS-CAPSYELLOW	Steel end cap	-	55	350	175

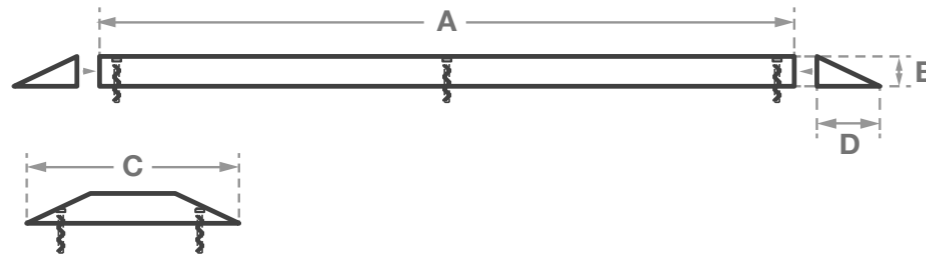

- S** Heavy duty steel
- W** Weather resistant
- I** Fast installation
- C** Checker plate non-slip surface

### Colour



Black/Yellow stripes



**LIFETIME WARRANTY**

**INSTALLATION SERVICES AVAILABLE**

**NCC COMPLIANT**

**AS2890 COMPLIANT**

## Classic

# Wheel Stops

- Designed to stop wheels, working as a boundary when parking a vehicle
- Practical and durable
- Concrete and rubber options
- Supplied with all fixings
- Easy to install

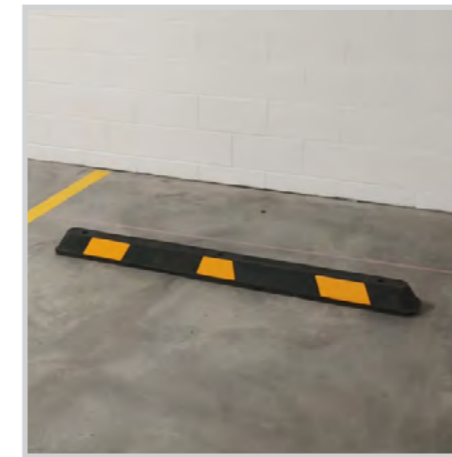

## Classic

# Wheel Stop

## Rubber

### Description

One piece moulded rubber wheel stop with visual inserts. Made from rubber it is the most practical wheel stop on the market. It is easy to install and does not require additional lifting equipment. Designed to be durable, it won't chip or corrode.

- Complies with AS2890.1-2004
- Moulded construction
- Won't chip or corrode
- Supplied with all fixings - screw bolts to suit concrete substrate, spikes to suit asphalt substrate

### Colour



### Application

Bitumen or concrete

### Fixings

3 x fixings

### Material

Rubber

Code	Description	A length (mm)	B height (mm)
PS165R	Rubber	1650	100

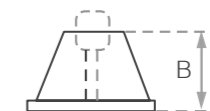
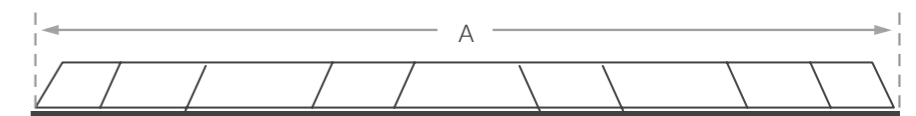

**LIFETIME WARRANTY**

**INSTALLATION SERVICES AVAILABLE**

**NCC COMPLIANT**

**AS2890 COMPLIANT**





Wheel Stops



# Classic Wheel Stop

Concrete

**Description**

Moulded in one piece and reinforced with internal steel rods for enduring strength and durability

- Complies with AS2890.1-2004
- Longer durability
- Corrosion and rot resistant
- Supplied with fixings

**Colour**



Grey

**Material**

Reinforced concrete

Code	Description	A length (mm)	B height (mm)
PS165R	Concrete	1650	100

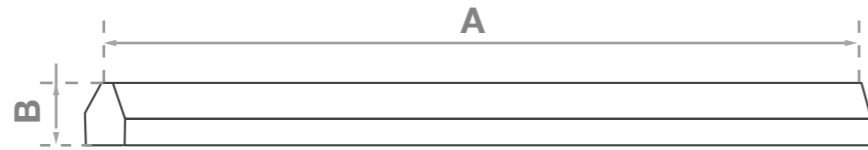

**LIFETIME WARRANTY**

**INSTALLATION SERVICES AVAILABLE**

**AS2890 COMPLIANT**

Weather resistant

UV Resistant

Fast installation



Classic

# Height Bars

- Designed to eliminate damage to vehicles and property caused by oversized vehicles entering areas of restricted height
- Yellow powder coated
- Different installation options available



Classic

## Height Bar

Clearance Protection Height Bar

### Description

Classic height bars are designed to eliminate damage to vehicles and property caused by oversized vehicles entering areas of restricted height. Often used in car parks, petrol stations and drive-throughs. The aluminium tube is powder coated safety yellow with red and white reflective diagonal stripes.

- Free standing surface mount or below ground posts are available for installation when there is no existing support structure
- Comes complete with hanger assemblies and chain (600mm length)

### Application

Various

### Material

Aluminium

### Colour



Safety Yellow

Code	Description	A length (mm)
PB20SP	Yellow powder coated low clearance height bar with text 2m (including chain and D shackles)	2000
PB30SP	Yellow powder coated low clearance height bar with text 3m (including chain and D shackles)	3000
PB50SP	Yellow powder coated low clearance height bar with text 5m (including chain and D shackles)	5000
PB KIT	Additional hanger kit	-
PB-SB	Adjustable stand off bracket (each)	500

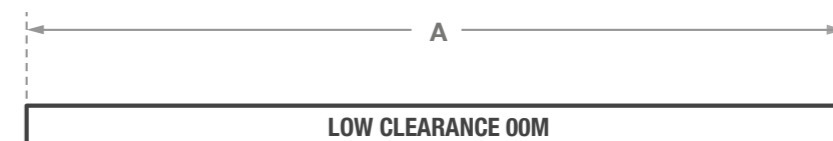

**LIFETIME WARRANTY**

**INSTALLATION SERVICES AVAILABLE**

- Aluminium tube
- Weather resistant

- Fast installation
- Powder coated

Classic

# Corner Guards

- Helps identify columns or obstruction in low light areas to prevent damage to vehicles and property
- Rubber, galvanised steel and stainless steel options
- Easy to install

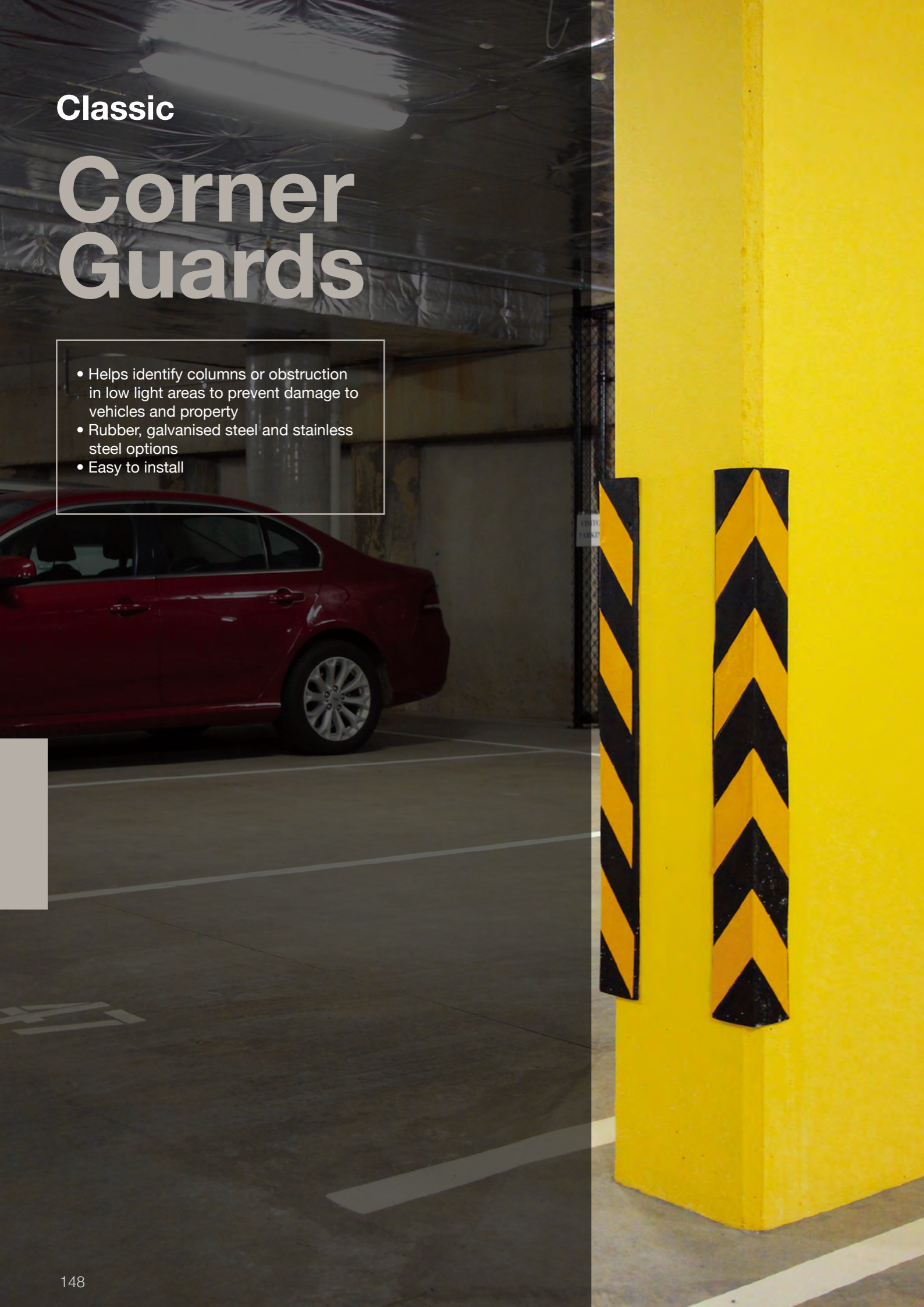

Classic

# Corner Guards

Rubber

### Description

Classic corner guards are designed to prevent damage to both vehicles and property, particularly in areas of restricted space. Ideal for loading docks and car parks. Made from recycled rubber with reflective panels.

- Helps identify columns or obstruction in low light areas
- Supplied with fixing holes

### Application

Corners of car park pillars and walls

### Material

Recycled rubber

### Colour



Black/Yellow stripes

Code	Description	A height (mm)	B width (mm)	C width (mm)
PC18R	Recycled rubber black/yellow corner guards	800	100	100

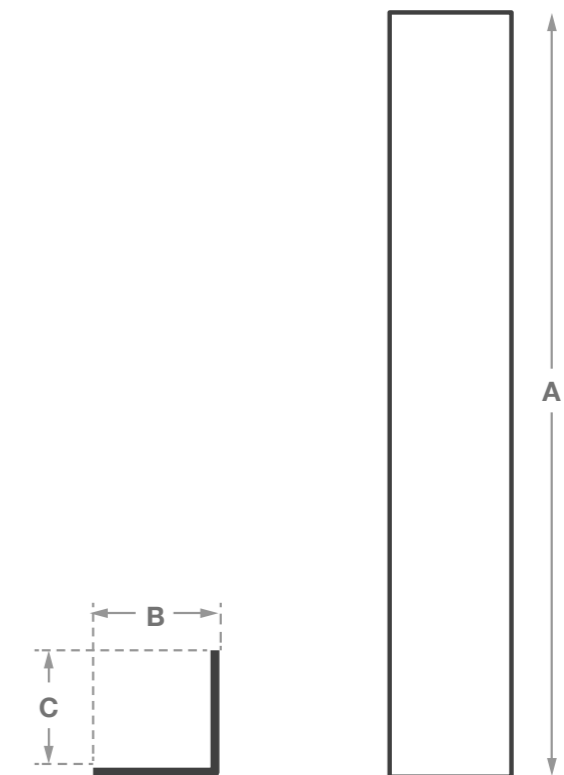

**LIFETIME WARRANTY**

**INSTALLATION SERVICES AVAILABLE**

Recycled rubber

Fast installation

Weather resistant

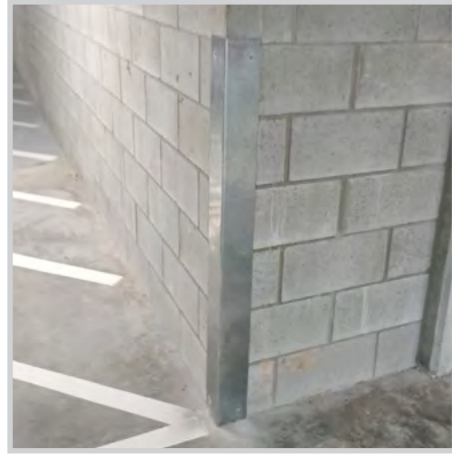

# Classic Corner Guards

## Galvanised Steel

### Description

Classic corner guards are designed to prevent damage to both vehicles and property, particularly in areas of restricted space. Ideal for loading docks and car parks.

- Ideal solution to protect column and pillar corners
- Easy to install

### Application

Corners of car park pillars and walls

### Material

Galvanised steel

### Colour



Galvanised

Code	Description	A height (mm)	B width (mm)	C width (mm)
PCG-C	2mm Galvanised Steel corner guards	1200	100	100

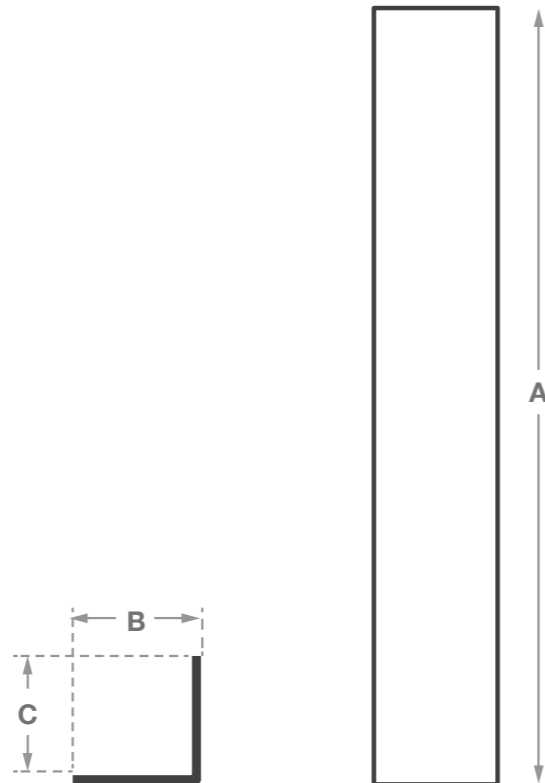

**LIFETIME WARRANTY**

**INSTALLATION SERVICES AVAILABLE**



# Classic Corner Guards

## Stainless Steel

### Description

Classic corner guards are designed to prevent damage to both vehicles and property, particularly in areas of restricted space. Ideal for loading docks and internal passage ways.

- Ideal solution to protect column and pillar corners
- Easy to install

### Application

Corners of car park pillars and walls

### Material

Stainless steel

### Colour



Stainless Steel

Code	Description	A height (mm)	B width (mm)	C width (mm)
PCG-C	2mm Stainless Steel corner guards	1200	100	100

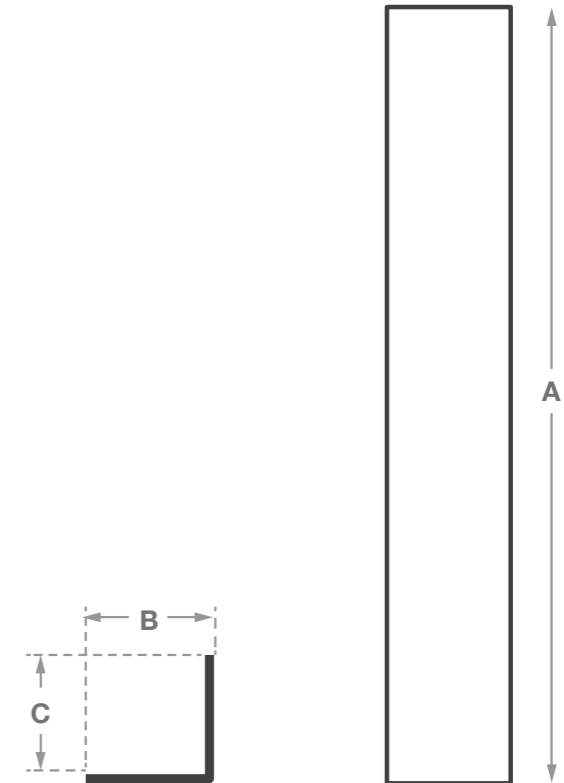

**LIFETIME WARRANTY**

**INSTALLATION SERVICES AVAILABLE**



Classic

# Convex Mirrors

- Designed to give broader vision in blind spots which can pose a risk to motorists and pedestrians
- Unbreakable polycarbonate face
- Interior and exterior use
- Different installation options available

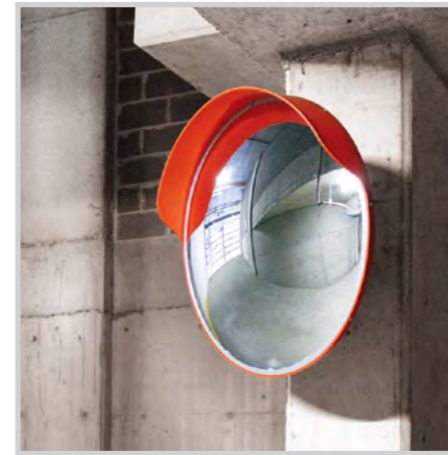

Classic

# Convex Mirrors

Interior and Exterior Use

### Description

Classic convex mirrors are durable and weather proof, suitable for road and pedestrian traffic applications, warehouses, distribution depots and car parks.

- Adjustable to any angle
- Extendable stand-off arm available
- Available with galvanised wall and post mount brackets

### Application

Interior and exterior

### Material

Unbreakable polycarbonate face

### Colour



High visibility orange visor

Code	Description	A size (mm)	B height (mm)	C width (mm)	D reach (mm)
IM60EX	Convex mirror with wall/post bracket	600	-	-	-
PT325GC	Galvanised post with cap, to suit core drilling	-	3250	60	-
PT280GC	Galvanised post with cap	-	2800	60	-
EA46SA	Extendable stand-off arm	-	-	-	400-600

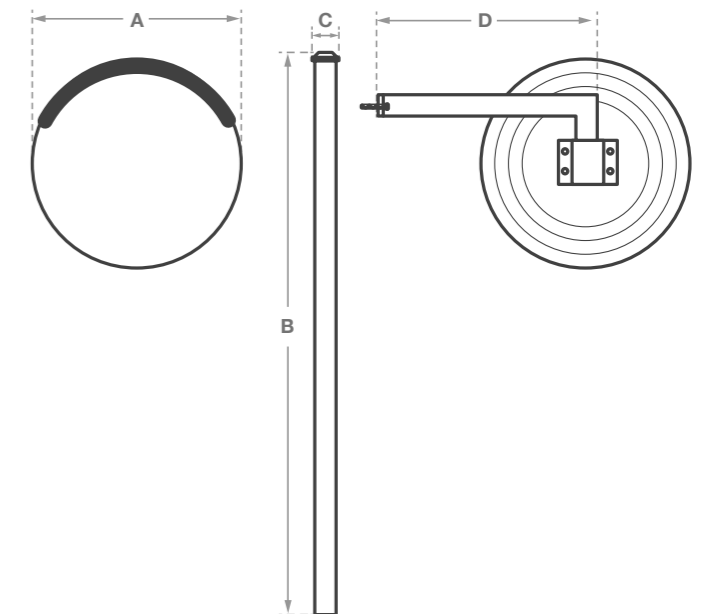

**LIFETIME WARRANTY**

**INSTALLATION SERVICES AVAILABLE**



Weather resistant



Fast installation

# Classic

# Signage

- Car park and street signs utilised as a method of warning and guiding drivers and pedestrians
- Expansive range of signs and fixings

**GIVE WAY**

# Signage



**STOP**

**Size:** 600mm x 600mm  
**Material:** Aluminium



**Give Way**

**Size:** 750mm  
**Material:** Aluminium

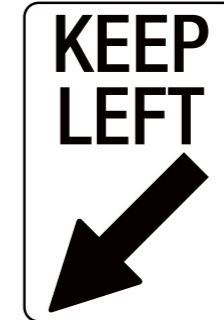

**Keep Left**

**Size:** 450mm x 600mm  
**Material:** Metal



**Keep Right**

**Size:** 450mm x 600mm  
**Material:** Metal



**One Way Left Arrow**

**Size:** 450mm x 600mm  
**Material:** Metal

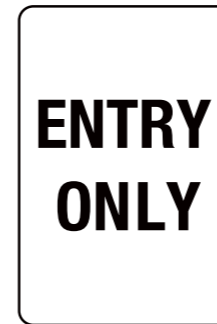

**Entry Only**

**Size:** 450mm x 600mm  
**Material:** Metal



**No Entry**

**Size:** 450mm x 450mm  
**Material:** Aluminium



**Speed Limit 10**

**Size:** 450mm x 600mm  
**Material:** Metal



**Pedestrian Crossing**

**Size:** 600mm x 600mm  
**Material:** Aluminium



**Loading & Unloading Zone**

**Size:** 450mm x 600mm  
**Material:** Metal



**Pedestrian Crossing Ahead**

**Size:** 600mm x 600mm  
**Material:** Aluminium



**Speed Hump Ahead**

**Size:** 300mm x 450mm  
**Material:** Metal

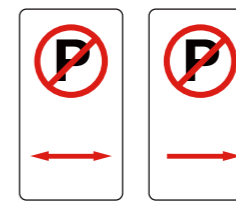

**No Parking**

**Size:** 225mm x 300mm  
**Material:** Aluminium



**Reserved Parking Only**

**Size:** 300mm x 450mm  
**Material:** Metal



**Reserved Disabled**

**Size:** 450mm x 300mm  
**Material:** Metal



**Disabled Parking**

Size: 225 x 450mm

Material: Metal



**No Vehicles Beyond this Point**

Size: 300mm x 450mm

Material: Metal



**Braille Male & Female Toilet**

Size: 180mm x 180mm

Material: PVC



**No Entry- Authorised Personnel Only**

Size: 225mm x 300mm

Material: Aluminium



**Disabled Parking Only**

Size: 225mm x 450mm

Material: Aluminium



**Bus Zone**

Size: 225mm x 450mm

Material: Aluminium



**Roundabout**

Size: 750mm

Material: Aluminium



**Shared Footpath**

Size: 300 x 400mm

Material: Aluminium

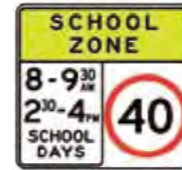

**School Zone**

Size: 850mm x 900mm

Material: Aluminium



**Shared Zone**

Size: 450mm x 750mm

Material: Aluminium



**Emergency Assembly Point**

Size: 600mm x 450mm

Material: Metal



**Video Surveillance**

Size: 450mm x 600mm

Material: Poly

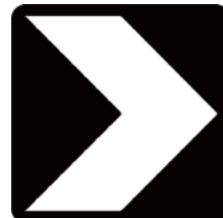

**Right Arrow (Chevron)**

Size: 450mm x 450mm

Material: Aluminium



**Bike Parking Only**

Size: 300mm x 450mm

Material: Aluminium



**Galvanised post with cap**

Size: 3200mm x 60mm

Material: Metal



**Single sided post bracket**

Size: (2 per sign)



**Double sided post bracket**

Size: (2 per sign)



**Base Plate**

Application: For Concrete

Size: For 60mm pole



**Arrow Socket Post Mounts**

Application: For Soil and Asphalt



# BIKE RACKS & SKATE DETERRENTS

## WHY CHOOSE CLASSIC?

- Consultative approach
- Customised solutions
- End-to-end fulfilment
- Unrivalled knowledge of standards
- Lifetime warranty
- Over 40 years' experience
- People and operations across Australia

Bike Racks - Hoop



- Designed to provide a safe bicycle storage solution in commercial applications
- Versatile bar
- Surface mount
- Hoop tops
- Stainless steel and galvanised options
- Ideal for schools, shopping centres, walkways or warehouses

Skatestop Disc

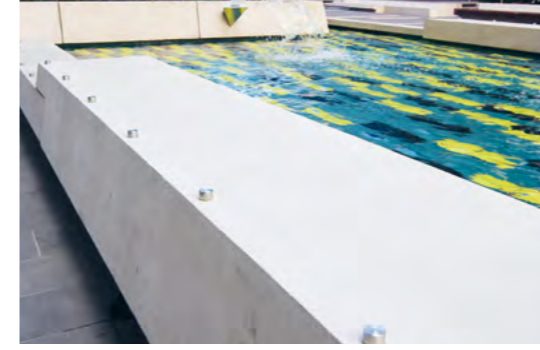

- Designed to deter the most determined skaters from using your external public areas
- Protects your landscape's presentation and longevity
- Rounded edges for safety
- Available in hard wearing stainless steel or solid brass
- Easy to install

Bike Racks - Wall



- Designed to provide a safe bicycle storage solution in commercial applications
- Versatile bar
- Designed to be wall mounted
- Black powder coated
- Ideal for schools, shopping centres, walkways or warehouses

Skatestop Edge



- Deters skaters without impacting visual environment
- Ability to intergrate into project design
- Available in hard wearing stainless steel or solid brass
- Easy to install
- Solid brass for a naturally beautiful aesthetic

Skatestop Max



- Best and most effective skatestop product
- Low profile and versatile design
- Deters both skating and bike users
- Acts like mini speed hump for your walls, planters and benches
- Available in hard wearing stainless steel or solid brass
- Easy to install



Classic

# Bike Racks

- Designed to provide a safe bicycle storage solution in commercial applications
- Surface mount or below ground options
- Hoop tops and wall mount varieties
- Stainless steel, galvanised and yellow powder coated options

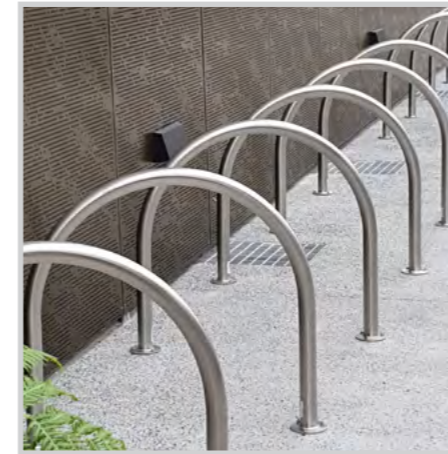

Classic

## Bicycle Racks - Hoop

Stainless Steel or Galvanised

### Description

Classic wall bicycle racks are a versatile bar with a wide range of applications. Available in surface mount, with stainless steel and galvanised options. Ideal for schools, shopping centres, walkways or warehouses.

### Application

Surface mount

### Material

Stainless steel or galvanised

### Colour



Stainless Steel Galvanised

Code	Description	Material	A above ground height (mm)	B width (mm)	C below ground depth (mm)
SR82SHB	Hoop bicycle rail with baseplate	Stainless Steel	800	850	
SR82GHB	Hoop bicycle rail with baseplate	Galvanised	800	850	

### HOOP TOP

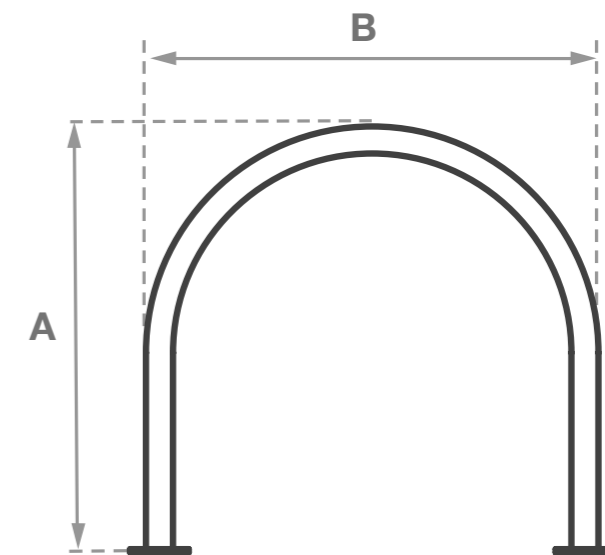

LIFETIME WARRANTY

INSTALLATION SERVICES AVAILABLE

NCC COMPLIANT

AS2890 COMPLIANT

Gal Galvanised

Powder coated (optional)

SS Stainless steel

Weather resistant



# Classic Bicycle Racks - Wall

Black Powder Coated

### Description

Classic bicycle racks are a versatile bar, designed to be wall mounted. Coming in a black powder coated finish, this product is ideal for schools, shopping centres, walkways or warehouses.

### Application

Wall mount

### Material

Black powder coated

### Colour



Black

Code	Description	Material	A height (mm)	B width (mm)
SR902BWF	Wall mount bicycle rack	Black Powder Coated	705	700

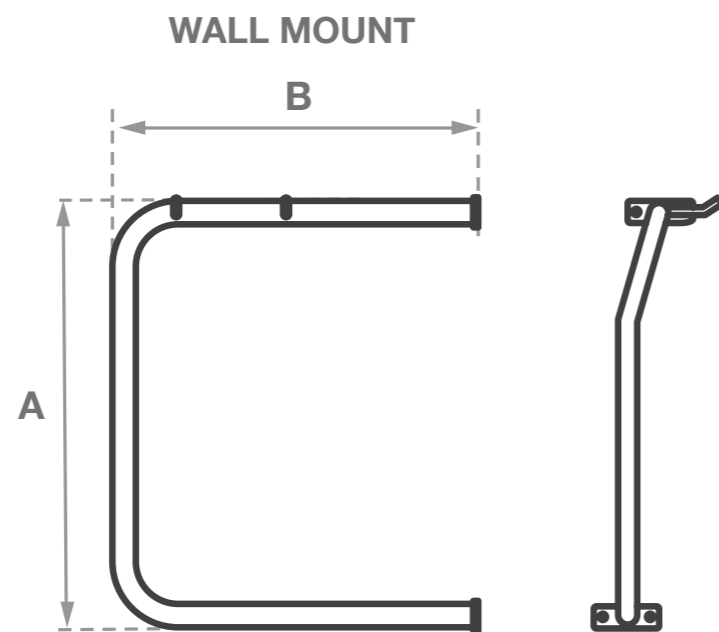

**LIFETIME**  
WARRANTY

**INSTALLATION**  
SERVICES  
AVAILABLE



Powder coated



Weather resistant



## Classic Skatestop

# Skate Deterrents

- Designed to deter the most determined skaters from using your external public areas as a free-for-all
- Protects your landscape's presentation and longevity
- Various options to suit the design aesthetic and level of prevention required
- Stainless steel for hard-wearing durability
- Solid brass for a naturally beautiful aesthetic

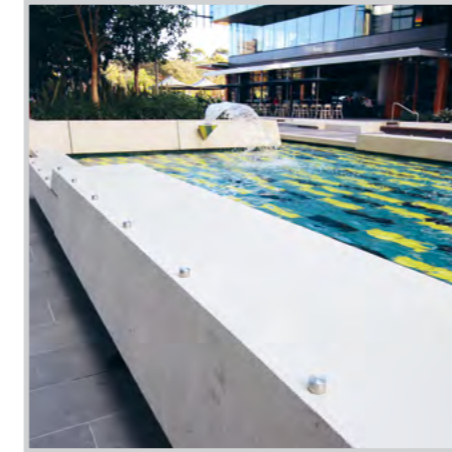

## Classic Skatestop

# Disc

## Basic Skate Deterrent

### Description

Classic Skatestop Disc blends in easily with most architectural themes, whilst minimising liability. Rounded edges make them safe and discrete with minimal impact. The Disc is very easy for DIY installations and for retro-fitting to existing areas. Classic Skatestop Disc is available in two options, marine grade stainless steel and solid brass.

### Profile

Round

### Diameter

30mm (Custom sizing available)

### Height

20mm (Custom sizing available)

### Material

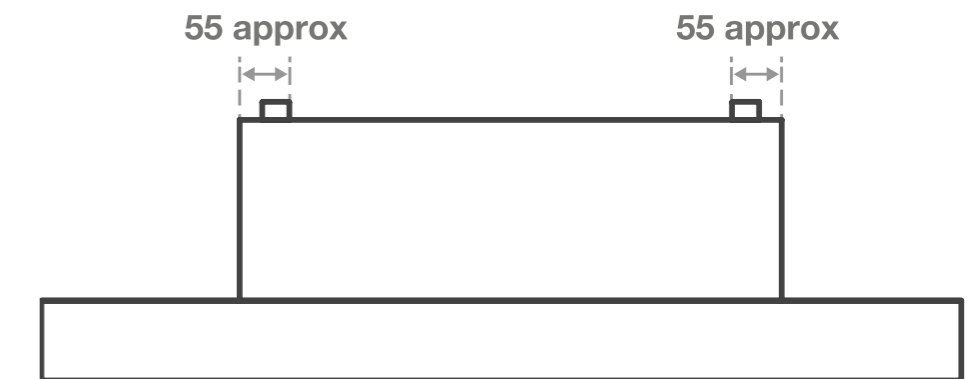

**LIFETIME  
WARRANTY**

**INSTALLATION  
SERVICES  
AVAILABLE**

 Round profile

 Fast installation

 Weather resistant

**SS** Stainless steel and solid brass



## Classic Skatestop

# Edge

### Advanced Skate Deterrent

#### Description

Classic Skatestop Edge deters skaters without impacting on the environment's visual or intended use. With the ability to be integrated into the project design, it's an easy installation, particularly into expansion joints and grout lines, but is also suitable for retro-fitting. Demanding applications require rugged solutions and that's where Edge performs. Classic Skatestop Edge is available in two options, marine grade stainless steel and solid brass.

#### Material



#### Profile

L-shape

#### Length

120mm

#### Height

55mm

#### Thickness

6mm

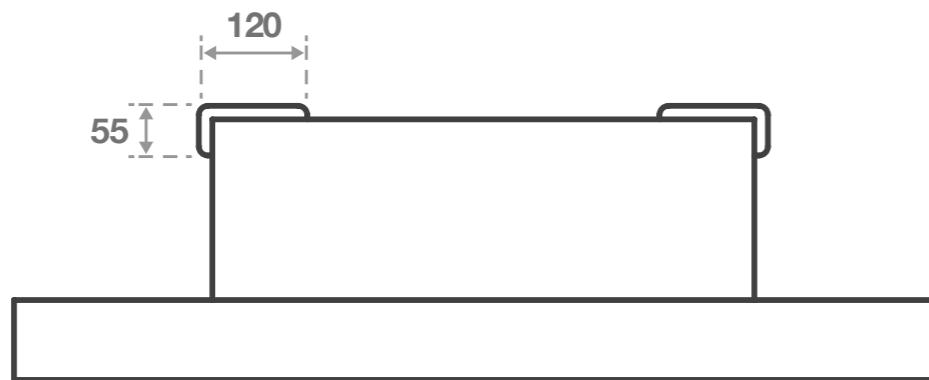

**LIFETIME  
WARRANTY**

**INSTALLATION  
SERVICES  
AVAILABLE**



**SS** Stainless steel and solid brass



## Classic Skatestop

# Max

### Ultra Effective Skate Deterrent

#### Description

The best and most effective Classic Skatestop. The Classic Skatestop Max features a low profile and versatile design. Classic Skatestop Max has been specially developed to deter not only skate boarding, but also biking as well by eliminating the long, smooth edges that landscapes often offer such users. In effect, Classic Skatestop Max is a mini speed hump for your walls, planters, benches and other architectural features. Classic Skatestop Max is available in two options, marine grade stainless steel and solid brass.

#### Material



#### Profile

Full width

#### Diameter

Custom

#### Height

Custom

#### Thickness

6mm

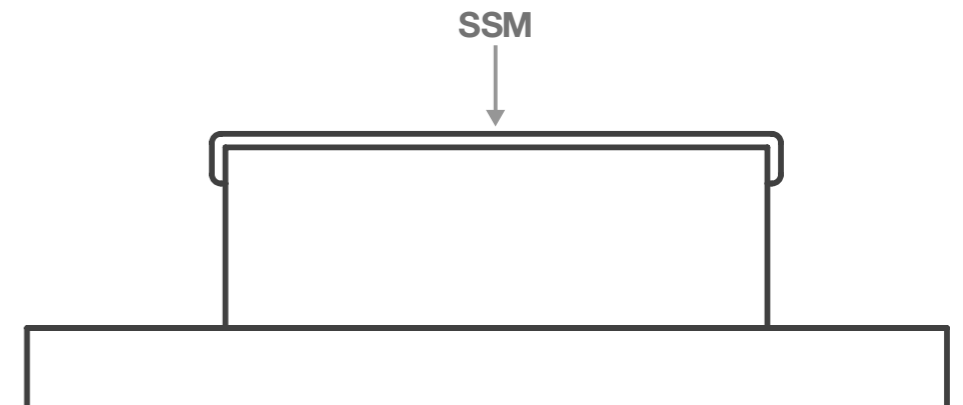

**LIFETIME  
WARRANTY**

**INSTALLATION  
SERVICES  
AVAILABLE**



**SS** Stainless steel and solid brass

# Reference Guides

Application Guides 170

Installation Guides 172

Care Guides 188



# Classic Tredfx Tactile Indicators

## Application Guide

### What are tactiles

Tactile Indicators are a series of organised raised dots and bars that are installed on pedestrian surfaces to assist in the orientation of people who are blind or vision impaired. Classic's range of Tactiles is primarily designed to give tactile warning to people so that they may safely negotiate the built environment.

Tactiles come in 2 main types:

#### Hazard/Warning - dots

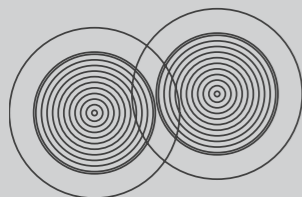

#### Directional - bars

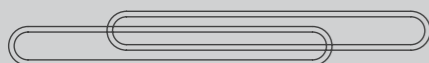

### Why are tactiles mandatory?

The following legislated codes and standards are very specific to the design, installation and placement of Tactiles to ensure a clear reading of Tactiles in all public spaces, and to ensure that the experience of the vision impaired remains consistent in the urban landscape.

#### 1. NATIONAL CONSTRUCTION CODE (BCA) - SECTION D CLAUSE 3.8

This document states what must be done as a legal minimum.

#### 2. AUSTRALIAN AND NEW ZEALAND STANDARDS AS/NZS1428.4.1-2009

This standard states the tactile design, layout and application.

#### 3. THE DISABILITY DISCRIMINATION ACT (DDA)

This Federal Act states why and within what context.

### Where are tactiles required?

Tactiles must be installed in accordance with the AS/NZS1428.4.1-2009 in areas that can be accessed by the general public such as: stairs, ramps, landings, escalators, travelators, pedestrian crossings and waiting platforms.

Tactiles must always be installed to the following AS/NZS1428.4.1-2009 requirements:

1. To the entire width of the accessible path of travel.
2.  $300 \pm 10$ mm back from the edge of the hazard (Except at rail platforms and wharves-  $600\text{mm} \pm 10\text{mm}$ ).
3. To a minimum depth of 600mm (Except enclosed landings to a minimum depth of 300mm).

#### Tactiles must always meet the following AS/NZS1428.4.1-2009 Luminance Contrast requirements:

1. Tactile Tiles – 30% to that of the surrounding substrate/surface area.
2. Individual Tactiles (One colour or material) – 45% to that of the surrounding substrate/surface area.
3. Individual Tactiles (Two colours or materials) – 60% to that of the surrounding substrate/surface area.

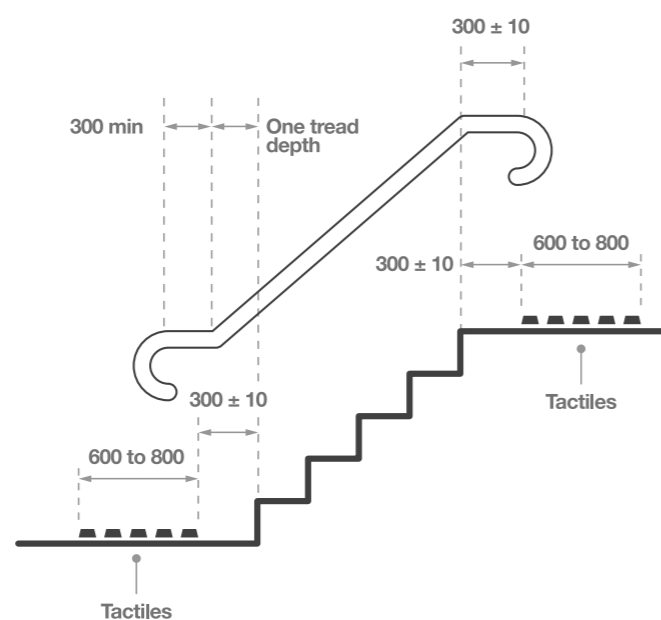

# Classic Tredfx Stair Nosings

## Application Guide

### What are stair nosings

Stair nosings are profiled strips of material, commonly aluminium, that are fitted on the edge of steps to assist in providing an anti-slip surface.

### Why are stair nosings mandatory?

The following legislated codes and standards are very specific to the design, installation and placement of Stair nosings.

#### 1. AUSTRALIAN STANDARDS AS1428.1

This standard states the stair nosing design, layout and application.

### Where are stair nosings required?

Stair nosings must be installed to the following AS1428.1 requirements:

1. To the entire width of the accessible path of travel.

#### Stair nosings must always meet the following AS1428.1 Luminance Contrast requirements:

1. Each tread is to have a minimum strip of 50mm and not more than 75mm deep across the width of the path of travel.
2. The nosing strip is to have a minimum contrast of 30% to the floor finish.
3. Nosing strip may be set back a maximum of 15mm from the front of the nosing.
4. If the aluminium has more than a 30% contrast with the floor finish, it shall not extend down the riser more than 10mm.

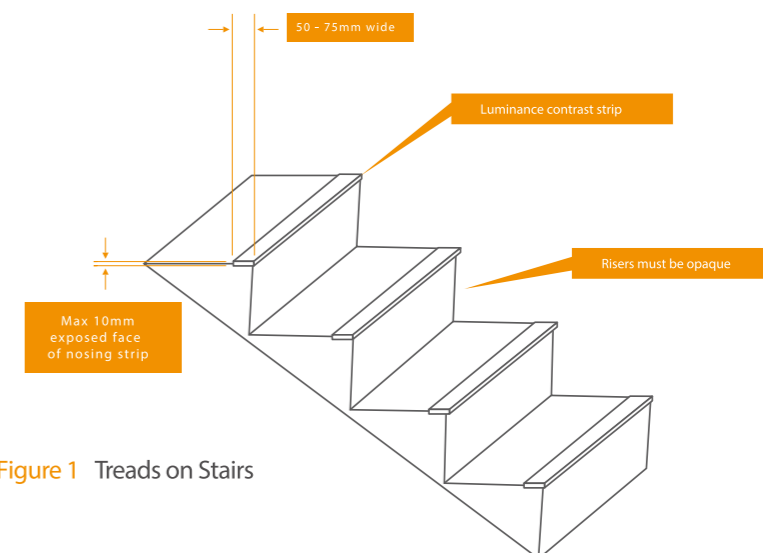

Figure 1 Treads on Stairs

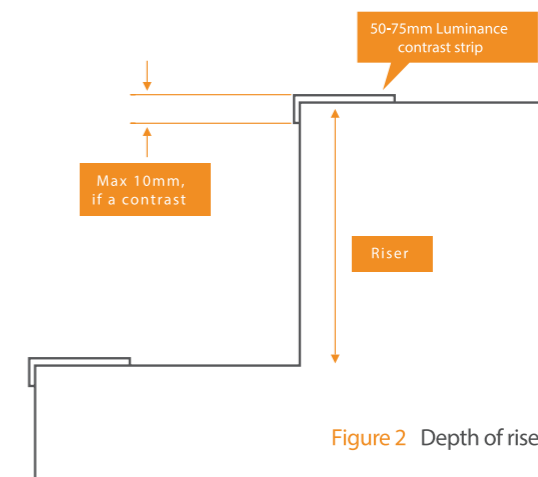

Figure 2 Depth of riser

**Depth of the riser:** Where the luminance contrast strip extends down the front of the stair, the strip cannot be more than 10mm. This limitation is to avoid confusing the location of the leading edge of the tread. If the front of the nosing body is not a contrast or "blends in", and it is clearly differentiated from the luminance contrast strip, then the stair nosing body can extend any distance down the riser.

# Classic Integra Entrance Mat Framing System

## Installation Guide

Integra frame is a versatile matwell framing system with five profiles that can be used for varying mat thicknesses. The Integra frame has been developed as part of the entrance systems program from Classic.

Integra frame is easily transported thanks to its modular design and is simple to install. Please be aware that a set-down or rebate may be required in the substrate.

## Warning

Do not alter pre-cut frames without consulting Classic Architectural Group. Any alterations to mat frames supplied may incur expensive additional costs and/or re-manufacture of the matting. All costs to be borne by the customer.

## Installation

### Recessed Application

1. If Integra Frame is not pre-cut to size, mitre cut to size or trim as required, ensuring the vertical leg is the correct size for the mat thickness.
2. Assemble Integra Frame by inserting corner clips as shown. Use a mallet or soft hammer if required.
3. Drill and countersink as required at approx 600mm centres to allow fixing to base slab/substrate.
4. Set out Integra Frame within mat well recess, ensuring that corners are square, diagonals are equal (for rectangular mats), and sides are straight.
5. Pack the frame adjacent to each fastener position so that the top of the frame is level with the finished floor level.
6. Fix the frame to the subfloor using countersunk fasteners.
7. Prepare a suitable mortar mixture and screed off to the top face of the horizontal leg of the frame. Ensure that the mat well is perfectly level.
8. Prepare the mat area for mat install and follow mat install procedure.

## Installation

### Ramp Frame Application

1. Layout Integra Frame INFR1180 to all required sides of matting in desired mat area in accordance with manufacturer's recommendations.
2. Install as supplied ensuring that the corners are square, diagonals are equal (for rectangular mats) and the sides are parallel. Where required trim the ramp frame to length, and/or mitre the corners to suit.
3. Fix the frame to the subfloor using countersunk fasteners ensuring that the frame is closely fitted to the floor surface.
4. Prepare the mat area for mat install and follow mat install procedure.

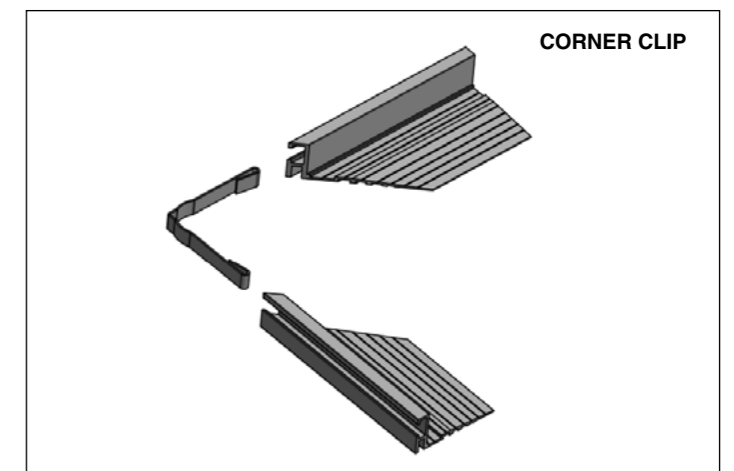
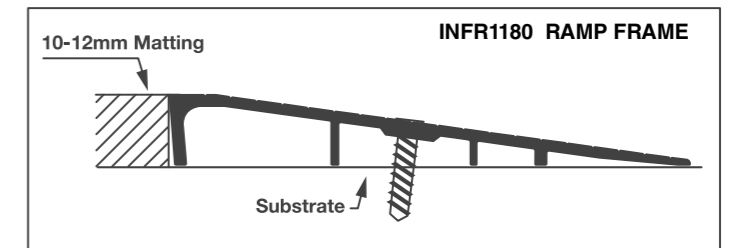
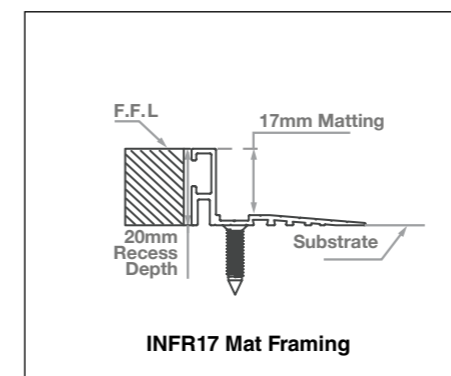
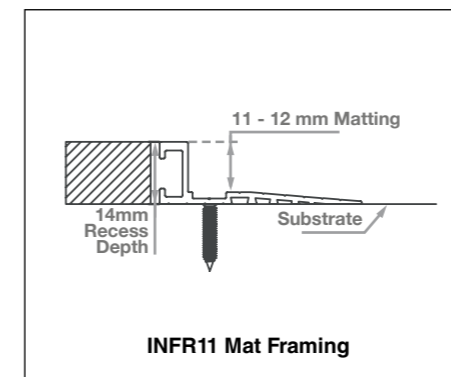
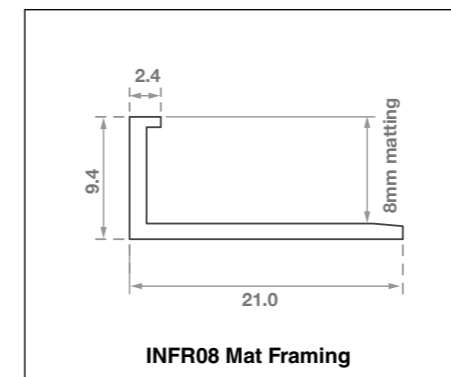
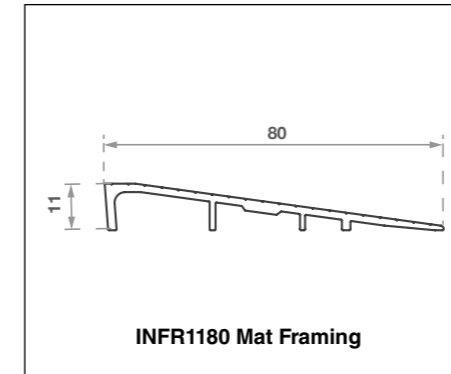

Corner clip supplied with INFR11 & INFR17 frame kits

# Classic Integra Vantt Entrance Matting

## Installation Guide

Install Classic Integra Vantt entrance matting featuring interlocking anodised aluminium scraperbars with matting inserts and flexible roll-up function. If required, install Integra INFR11 aluminium mat frame to suit recess, or INFR1180 ramp frame for surface mounted applications, in accordance with manufacturer's recommendations.

## Warning

Please check the product supplied, and read the entire instructions before starting any installation, then follow the steps. Do not alter pre-cut mats or frames without consulting Classic Architectural Group. Any alterations to mats or frames supplied may incur expensive additional costs and/or remanufacture of the matting. All costs to be borne by the customer.

## Installation

### Recessed Application

1. Install Classic Integra Frame in an oversized recess, locate, align and level frame accurately to adjoining floor levels in accordance with manufacturer's recommendations (as per frame installation guide).
2. Prior to installation, ensure the created matwell is clean and free from all construction debris, and the sub floor is flat, sound and free of contaminants. **WARNING!** Mats will be damaged by uneven mat wells. If necessary, prepare a suitable mortar mixture and screed off to the top face of the horizontal leg of the frame.
3. Accurately check and measure mat and frame.
4. In cases of shaped or circular mats, a RIGID template should be taken of the mat area and the template will be used to shape the mat as required. All shaping should be carried out by qualified and trained personnel - please refer to Classic Architectural Group for assistance.
5. Remove the Classic Integra Vantt mat from the packaging, and commence the installation as shown in Figures A-C. Do not try to force a mat section into place. (Please note the direction of travel. The mat ribs are to run perpendicular to the direction of travel.)
6. Most mats are made as a complete panel to suit your recess. However in the case of larger mats where the mat has been supplied in sections, the panels can be easily joined together by linking the 'ball and socket' connection as shown in Fig.B, using a rubber mallet to ensure a sound connection.
7. Install each mat section as per layout drawing supplied. Each mat has a lettered/numbered label attached and must be placed in the mat well (label on the top surface) to correspond with the layout drawing.
8. Once the mat has been fully installed, the black finishing strip on the end of the mat as shown in Fig. C (where fitted) can be carefully trimmed to size using a sharp knife and straight edge to ensure a snug fit against the frame.
9. Finally, ensure that the Classic Integra Vantt mat sections are placed tightly against one another, and each panel is properly connected, taking particular care that the edges of the mats are flush and are not presenting a tripping hazard.

## Installation

### Surface Mount Application

1. Install Classic Integra Ramp Frame to all required sides of matting in desired mat are in accordance with manufacturer's recommendations (see frame installation guide).
2. Prior to installation, ensure the created mat well is clean and free from all construction debris, and the sub floor is flat, sound and free of contaminants. **WARNING!** Mats will be damaged by uneven mat wells. If necessary, prepare a suitable mortar mixture and screed off to the top face of the horizontal leg of the frame.
3. Assemble and fit the matting following procedure outlined in prior steps 3-9.

### A Starting the frame (first unroll mat panels into mat-well)

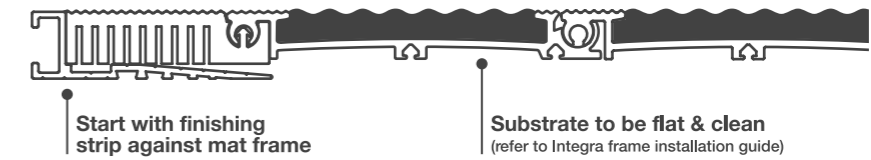

### B Joining mat sections

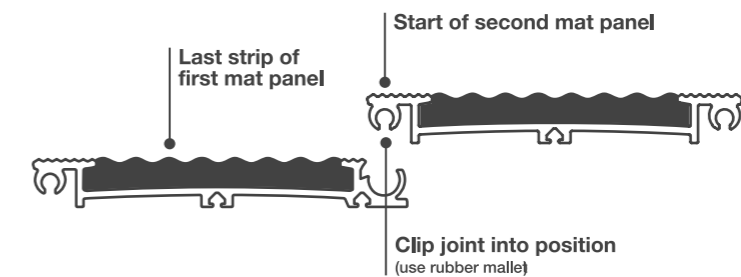

### C Ending the mat

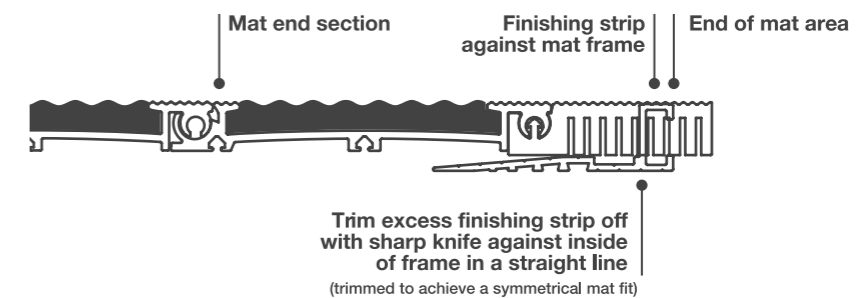



# Classic Integra Verse Entrance Matting

## Installation Guide

Install Classic Integra Verse reversible entrance matting, featuring aluminium scraper bars with wiper strips. If required, install Integra INFR11 or INFR17 aluminium mat frame to suit recess, or INFR1180 ramp frame for surface mounted applications, in accordance with manufacturer's recommendations.

### Warning

Please check the product supplied, and read the entire instructions before starting any installation, then follow the steps.

Do not alter pre-cut mats or frames without consulting Classic Architectural Group. Any alterations to mats or frames supplied may incur expensive additional costs and/or re-manufacture of the matting. All costs to be borne by the customer.

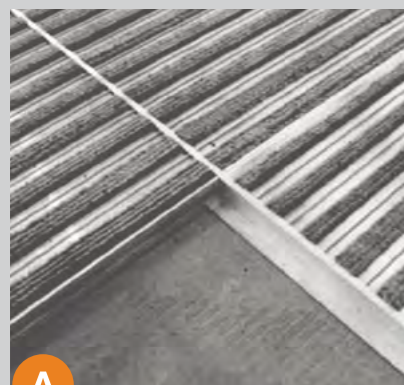

## Installation

### Recessed Application

1. Install Classic Integra Frame in an oversized recess, locate, align and level frame accurately to adjoining floor levels, in accordance with manufacturer's recommendations (as per frame installation guide).

2. Prior to installation, ensure the created matwell is clean and free from all construction debris, and the sub floor is flat, sound and free of contaminants. **WARNING!** Mats will be damaged by uneven mat wells. If necessary, prepare a suitable mortar mixture and screed off to the top face of the horizontal leg of the frame.

3. Accurately check and measure mat and frame.

4. In cases of shaped or circular mats, a RIGID template should be taken of the mat area and the template will be used to shape the mat as required. All shaping should be carried out by qualified and trained personnel - please refer to Classic Architectural Group for assistance.

5. Remove the Classic Integra Verse mat from the packaging, and commence the installation. Do not try to force a mat section into place. The process of installing factory made customised mats is straight forward and requires no special tools (Please note the direction of travel. The mat ribs are to run perpendicular to the direction of travel).

6. Classic Integra Verse products are loose laid, and there are no clips or joining pieces. Generally the mat will have been supplied in multiple rigid sections, and each section abuts naturally to each other.

7. Install each mat section as per layout drawing supplied. Each mat has a lettered/ numbered label attached and must be placed in the mat well (label on the top surface) to correspond with the layout drawing.

8. Place the first panel into the recess ensuring a good fit against the frame on all 3 sides, followed by the 2nd panel etc.

9. Where mats are over 2.4m in the L-R direction, mats will be made in multiple panels. Install the left hand panels first, then fit the 'T'-Bars in the inverted format as shown in Fig.A, then fit the centre panels, the next 'T'-Bar and the next panels etc. Each section abuts naturally to each other, and into the 'T'-Bar.

10. Finally, ensure that the Classic Integra Verse mat sections are placed tightly against one another, and each panel is properly fitted, taking particular care that the edges of the mats are flush and are not presenting a tripping hazard.

## Installation

### Surface Mount Application

1. Install Classic Integra Ramp Frame to all required sides of matting in desired mat area in accordance with manufacturer's recommendations (see frame installation guide).

2. Prior to installation, ensure the created matwell is clean and free from all construction debris, and the subfloor is flat, sound and free of contaminants. **WARNING!** Mats will be damaged by uneven mat wells. If necessary, prepare a suitable mortar mixture and screed off to the top face of the horizontal leg of the frame.

3. Assemble and fit the matting following procedure outlined in prior steps 3-8.

# Classic Integra Link Entrance Matting

## Installation Guide

Install Classic Integra Link entrance matting incorporating high performance open grid polymeric tiles, with 100% polyamide non-static tufted pile inserts, and heel-proof scraper panels. If required, install Integra INFR17 aluminium mat frame to suit recess, or INFR1180 ramp frame for surface mounted applications, in accordance with manufacturer's recommendations.

### Warning

Please check the product supplied, and read the entire instructions before starting any installation, then follow the steps.

Do not alter pre-cut frames without consulting Classic Architectural Group. Any alterations to mats or frames supplied may incur expensive additional costs and/or re-manufacture of the matting. All costs to be borne by the customer.

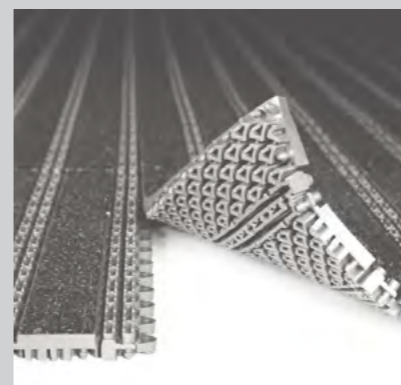

## Installation

### Recessed Application

1. Install Classic Integra Frame in an oversized recess, locate, align and level frame accurately to adjoining floor levels, in accordance with manufacturer's recommendations (as per frame installation guide).

2. If necessary, prepare a suitable mortar mixture and screed off to the top face of the horizontal leg of the frame. Prior to install, ensure the created matwell is clean and free from all construction debris, and the subfloor is flat, sound and free of contaminants. **WARNING!** Mats will be damaged by uneven mat wells.

3. Accurately check measure mat and frame.

4. In cases of shaped or circular mats, a RIGID template should be taken of the mat area and the template will be used to shape the mat as required. All shaping should be carried out by qualified and trained personnel - please refer to Classic Architectural Group for assistance.

5. Remove the Classic Integra Link tiles from the packaging, and commence the assembly of the mat. The tiles can be easily joined together by locating the 'male' and corresponding 'female' connection using a rubber mallet to ensure a sound connection (Please note the direction of travel the mat ribs/panels are to run perpendicular to the direction of travel). Suggestion: Larger mats can be constructed in several sections. For example a good guide is no more than 4 tiles L-R and 14 tiles F-B. Keeping within these sizes will ensure ease of handling and maintenance.

6. Once the required size has been achieved, the Classic Integra Link mat can be carefully laid into the desired position, and trimmed to size using a sharp knife and straight edge.

7. Finally, ensure that the Classic Integra Link mat sections are placed tightly against one another, and each tile is properly connected, taking particular care that the edges of the mats are flush and are not presenting a tripping hazard.

## Installation

### Surface Mount Application

1. Install Integra Ramp Frame to required sides of matting in desired mat area in accordance with manufacturer's recommendations (as per frame installation guide).

2. Prior to installation, ensure the created matwell is clean and free from all construction debris, and the subfloor is flat, sound and free of contaminants. **WARNING!** Mats will be damaged by uneven mat wells. If necessary, prepare a suitable mortar mixture and screed off to the top face of the horizontal leg of the frame.

3. Assemble and fit the matting following procedure outlined in prior steps 3-7.

# Classic Integra Zeal, Zone, Zoit, Premier and Tough Matting

## Installation Guide

Install selected Classic Integra carpet style entrance matting. If required, install Integra INFR08 aluminium mat frame to suit recess, or bevelled rubber edging for loose lay applications, in accordance with manufacturer's recommendations.

### Warning

Carpet and roll stock style mats must be fully unrolled and laid flat to allow the material to acclimatize for a minimum of 24 hours prior to the installation.

Please check the product supplied and read the entire instructions before starting any installation, then follow the steps.

Do not alter any pre-cut mats or frames without consulting Classic Architectural Group. Any alterations to mats or frames supplied may incur expensive additional costs and/or re-manufacture of the matting. All costs are to be borne by the customer.

### Installation

#### Recessed Application

1. Clean / vacuum out the mat well, and ensure the mat frame is correctly installed.
2. Ensure that the mat well is perfectly smooth and level. If necessary, prepare a suitable mortar mixture and screed off to the top face of the horizontal leg of the frame.
3. If required, trim the matting with a sharp knife to fit exactly to the inside of the frame.
4. Adhesive fix the matting to the substrate.

### Installation

#### Loose Lay Application

1. If required, trim the matting with a sharp knife to the exact size.
2. Adhesive fix bevelled edges to all required sides of the matting.

# Classic Integra Urban and Studio Matting Tiles

## Installation Guide

Install selected Classic Integra matting tiles. If required, install Integra INFR08 aluminium mat frame to suit recess, or bevelled rubber edging for loose lay applications, in accordance with manufacturer's recommendations.

### Warning

Classic Integra carpet tile style matting must be allowed to acclimatise for a minimum of 24 hours prior to the installation.

Please check the product supplied, and read the entire instructions before starting any installation, then follow the steps.

Do not alter any pre-cut mats or frames without consulting Classic Architectural Group.

Any alterations to mats or frames supplied may incur expensive additional costs and/or re-manufacture of the matting. All costs are to be borne by the customer.

### Installation

Lay the Carpet Tiles following normal established methods as per AS/NZS 2455.2.

1. Clean / vacuum out the mat well / substrate and ensure the mat frame is correctly installed to the correct heights.
2. Suitably prepare the substrate to receive the carpet installation to AS/NZS 2455.1 and AS/NZS 2455.2., including the following:
  - a) Remove deleterious and loose material, including surface treatments which could adversely affect adhesion. Leave the surface dust-free and clean.
  - b) Prep surface finish as required. Infill depressions with a suitable filler, and remove high spots and projections. If necessary, apply an even screed with a steel trowel. Alternatively, a self leveling compound may be used.

3. Concrete substrates: Test concrete substrate for dryness using the hygrometer test method described in AS/NZS 2455.1 Appendix B. If necessary use artificial means for drying out the substrate before installation.

4. Carpets shall not be laid until the moisture content of the substrate is in accordance with the requirements of AS/NZS 2455.1.

5. Layout entrance area using chalk lines to establish straight lines and starting points, and laying method being:

6. Lay Carpet Tiles in accordance with AS/NZS 2455.2, fixing with a suitable proprietary pressure sensitive adhesive, suitable for holding tiles in position without permanent sticking. Primer shall be used where recommended by the adhesive manufacturer and shall be allowed to dry thoroughly before applying adhesive.

7. Spread the adhesive evenly as per adhesive manufacturer's recommended directions, pressing carpet tiles down firmly and rolling (if recommended) to ensure full contact and a good bond overall.

8. Remove all surplus adhesive from exposed faces of coverings as work proceeds.

9. Where required, trim the carpet tile matting with a sharp knife to fit.

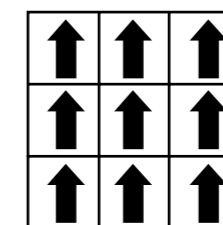

"Monolithic"

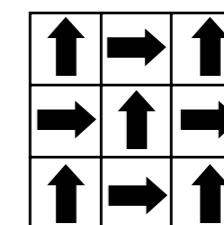

"Quarter Turn"

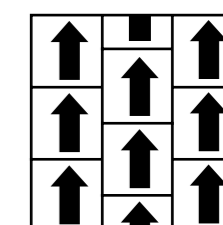

"Brick / Ashlar"

Tiles have a direction arrow on the underside.

# Classic Integra Shield Matting

## Installation Guide

Install Classic Integra Shield entrance matting, comprising of resilient vinyl coiled loops. If required, install Integra aluminium mat frame to suit recess, or bevelled rubber edging for loose lay applications, in accordance with manufacturer's recommendations.

### Warning

Carpet and roll stock style mats must be fully unrolled and laid flat to allow the material to acclimatise for a minimum of 24 hours prior to the installation.

Your scraper matting has been supplied slightly oversize to allow for any stretching or shrinkage that may occur during acclimatisation.

Please check the product supplied, and read the entire instructions before starting any installation, then follow the steps.

Do not alter any pre-cut mats or frames without consulting Classic Architectural Group. Any alterations to mats or frames supplied may incur expensive additional costs and/or re-manufacture of the matting. All costs are to be borne by the customer.

### Installation

#### Recessed Application

1. Clean / vacuum out the mat well, and ensure the mat frame is correctly installed.
2. Ensure that the mat well is perfectly smooth and level. If necessary, prepare a suitable mortar mixture and screed off to the top face of the horizontal leg of the frame.
3. If required, trim the matting with a sharp knife to fit exactly to the inside of the frame.
4. Adhesive fix the matting to the substrate.

### Installation

#### Loose Lay Application

1. If required, trim the matting with a sharp knife to the exact size.
2. Adhesive fix bevelled edges to all required sides of the matting.

# Classic Tredfx Stair Nosings

## Installation Guide

### Preparation

All surfaces should be flat, free from dust, paint, grease and moisture. Prepare the surface to be as smooth as possible. Any irregularities\* must be corrected before installation of the stair nosing profile.

**NOTE:** It is imperative that damaged and worn treads are repaired using a suitable structural filling compound.

### Layout

Layout the stair nosing profiles on the stairs, or use a straight edge or string line to ensure that all the stair nosings are properly centred on the steps, with the edges aligned. If required, trim the profiles using a drop saw with a high speed tungsten carbide blade.

**NOTE:** We strongly recommend allowing approx. 50mm gap from each end of the stair nosing profile to the stair stringer/walls, and also expansion gaps at approx. 3 metre intervals (where the nosings are in a long run) to assist with possible thermal expansion, and to allow for water egress.

Please check the product supplied, and read the entire instructions before starting any installation, then follow the steps

All Tredfx aluminium stair nosings that feature concealed fixings are supplied with screw holes pre-drilled and countersunk. There is two screw holes drilled (one towards the front and one towards the back of the nosing) at 250mm intervals. One screw is supplied per every 250mm of nosing.

**NOTE:** Do not put a screw in every hole, only one screw per 250mm. Recommended installation method is to install the stair nosings with the screws in a staggered pattern (one screw in front hole, one screw in back hole, repeating). If in doubt as to correct installation methods, contact our customer service team on 1300 244 377.

## Installation

### Mechanical Fixings

For concrete, timber, tiled, masonry, carpeted/metal substrates

1. Using the pre-drilled stair nosings as templates, mark the hole locations on the step by spotting with a drill. Alternatively, we suggest fixings approximately 300mm apart, alternating between the middle and back of the profile. (Fig A)

2. Remove the nosing and drill the holes into the step (stair nosings are supplied with fasteners - please check application and fasteners first).

**NOTE:** In the case of tiled or masonry stairs, extreme care must be taken to ensure step edge does not crack or shatter. In the case of timber or metal stairs, drilling a pilot hole with a smaller drill bit may be necessary.

3. Once the holes have been drilled, ensure all surfaces are thoroughly clean and free of dust. (Fig B)

4. Insert plugs into holes and apply structural adhesive (e.g. Tredfx CA290 adhesive) to underside of stair nosing profile (2 or 3 beads to the riser edge and beside screw holes along the entire length) to cushion any step variance and to prevent the nosing from rocking. (Fig C)

5. Place nosing down onto step and firmly screw into place using the screws provided. The stair nosings must be firm and the fasteners flush. (Fig D & E)

6. Once the stair nosing base has been securely and satisfactorily installed, the slip-resistant inserts can be fitted into place. Refer to the specific method, which applies to your application.

## Installation

### Mechanical Fixings

For carpeted substrates

1. For best results, remove both the carpet and the underlay from step edge, and install the stair nosing with the rear gripper section overlapping the carpet. A packer may be required to raise the carpet thickness.

2A. Where the stair nosing is designed to be installed over broadloom type carpet (i.e. Tredfx PBC102), use the pre-drilled stair nosing as a template to mark the fixing positions on to the carpet, then punch holes out of the carpet using a suitable wad punch.

2B. Where installing a nosing to suit carpet tiles (i.e. Tredfx PBD106), trim back the tiles to suit the width of the profile.

3. Mechanically fix stair nosings into substrate following each prescribed procedure for either concrete or timber stairs.

4. Once the stair nosing base has been securely and satisfactorily installed, the slip-resistant inserts can be fitted into place. Refer to the specific method, which applies to your application.

**NOTE:** If the stair nosings are fitted over the carpet, it is very important that they are securely fixed down, as carpet can compress over time, loosening the fasteners.

## Installation

### Adhesive Fixing

For stone, tiled, masonry, timber substrates

1. Ensure that all surfaces are thoroughly clean. (Fig F)

2. Apply structural adhesive (e.g. Tredfx CA290 adhesive) to underside of stair nosing profile (at least 3 or 4 beads along the entire length including the riser edge) to cushion any variance and to prevent nosing from rocking. (Fig G)

3. Place nosing down onto step and firmly tap with rubber mallet to ensure good adhesion and to displace any trapped air.

4. The stair nosings must be a firm, flush finish. Ensure the stair nosings are securely held to the step edge using tape or weights, and are free of all traffic until the adhesive has achieved its full cure (allow 24 hours).

5. Once the stair nosing base has been securely and satisfactorily installed, the slip-resistant inserts can be fitted into place. Refer to the specific method, which applies to your application.

### Install Slip-resistant Poly Inserts (where supplied)

1. Pre-cut the insert approximately 30mm longer than required for the stair nosing.

2. Carefully peel off the adhesive backing strip (Fig H) and start to mould the insert into place. Do not stretch the insert.

**NOTE:** It is extremely important that the insert is relaxed when being installed. If the insert is stretched, it may in time shrink/return to its original size and be too short.

3. Once insert has been fitted, carefully trim off the excess with a sharp knife so that it is flush with the end of the nosing.

**NOTE:** If the stair nosings are fitted over the carpet, it is very important that they are securely fixed down, as carpet can compress over time, loosening the fasteners.

### Install Slip-resistant Gritted / Aluminium Style Inserts (where supplied)

1. Carefully peel off the adhesive backing strip (Fig H) and start to fit the insert into place.

2. Once the insert is fully into the base, firmly tap with rubber mallet to ensure good adhesion and displace any trapped air to achieve a firm, flush finish.

3. The stair nosings must be a firm, flush finish. Ensure the stair nosings are securely held to the step edge using tape or weights and are free of all traffic until the adhesive has achieved full cure (allow 24 hours).

**NOTE:** This information is offered as a general guide only and specific advice should always be sought from a reputable and accredited stair nosing installer before undertaking any installations.

Whilst Classic Architectural Group has made every effort to ensure the accuracy and effectiveness of this information, it makes no representation as to the accuracy or effectiveness of the information and takes no responsibility for any loss, damage or injury which may be caused as a direct or indirect result of the use of this information.

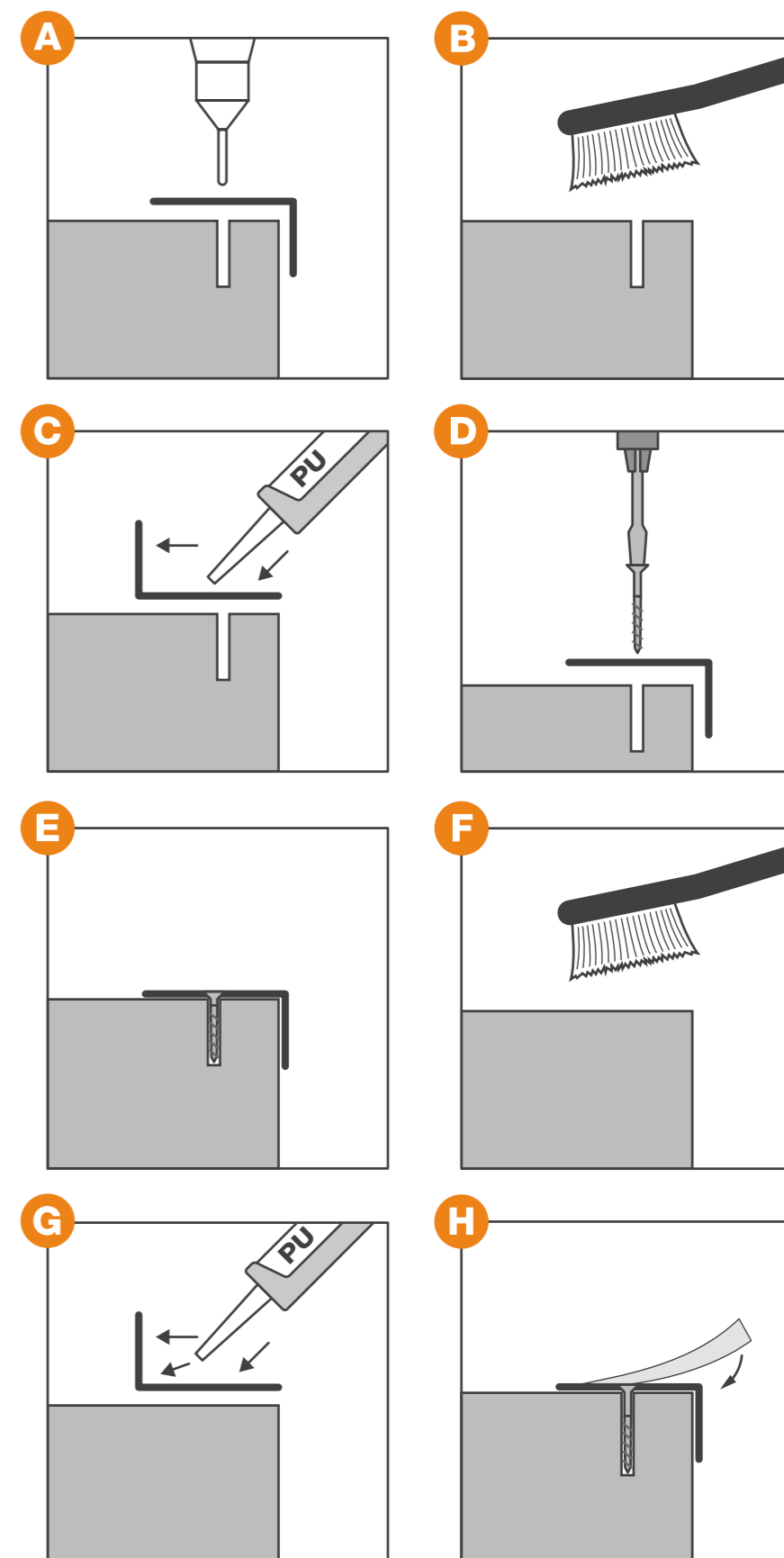

# Classic Tredfx Tactile Indicators: Tiles

## Installation Guide

### Layout

It is very important that prior to installation, the project is planned and set out to achieve a satisfactory and compliant result.

Tactile Ground Surface Indicators (TGSIs) must be installed in accordance with AS1428.4 .1-2009

Generally, at stairs the TGSIs must be installed 300mm from leading nosing edge at top and bottom of the stair flight 600mm deep to the full width of the path of travel.

For ramps, TGSIs must be installed 300mm from change in plane 600mm deep to the full width of the path of travel.

Layout the TGSIs in the designated areas, using a straight edge / string line or tape to ensure the lines are straight.

### Preparation

To be in accordance with AS 1884 'Floor coverings Resilient sheet and Tile Laying Maintenance Practices'.

Substrates must be virgin, uncontaminated, unsealed and free of hydrostatic pressure. All surfaces to be bonded shall be dry, smooth, sound and clean, to ensure adhesive has maximum surface area contact with substrate.

Any surface irregularities must be corrected before installation of the TGSIs.

**Note:** We don't recommend that Classic PT30A Tactile tiles are installed over asphalt surfaces

Please check the product supplied is suitable to your application and complies with the Australian Standards, and read the entire instructions before starting any installation, then follow the steps.

1. Thoroughly clean the surfaces from all dirt, moisture and grime, and conduct a final clean with a suitable non-residual cleaner such as Acetone. Always check in a non-obvious area to ensure the cleaner does not damage the substrate in any way.

2. Layout areas for installation using masking tape as a guide.

### Installation

#### Self-Adhesive Fixing – Stone, tile, masonry and timber substrates

For PT30A tiles with self adhesive backing

TIP: In the case that the weather is below 15°C, pre-lay the tiles out in the sun / in a warm position so they are not cold and use a heat gun to warm up the substrate. The adhesive is a butyl-based product, so the warmer that the product and surfaces are the better the adhesion.

1. After preparation, remove release paper from the back of the TGSIs tile and place the tactile into position.

2. Using a rubber hammer tap lightly to make sure full adhesion occurs, and the edges are flat.

3. The TGSIs can be walked on immediately.

### Installation

#### Wet Glue Fixing – Stone, tile, masonry and timber substrates

For PT30A tiles with self adhesive backing

1. After preparation, thoroughly mix a suitable proprietary adhesive suitable for bonding the TGSIs tiles to your particular substrate. (Classic does not supply this adhesive, and a primer may also be required where recommended by the adhesive manufacturer)

2. Spread the adhesive evenly to the adhesive manufacturer's recommendations using a notched trowel over the predetermined installation zone.

3. Apply the TGSIs tile into the adhesive and firm into place.

4. Roll lightly and check that full transfer of the adhesive to the back of the tile has occurred. Should the Tactiles not tend to sit flat, then assistance should be given in holding down with weights until full adhesive cure has been reached.

5. Any excess adhesive that is exposed should be immediately removed.

6. Ensure the TGSIs are free of all traffic until the adhesive has achieved its full cure

### Installation

#### Self-Adhesive Fixing – carpeted substrates

For PT30A tiles with self adhesive backing

1. For best results, prior to install, discuss your particular scenario with a Classic consultant to ensure you understand the methodology of installing TGSIs to carpeted areas.

2. Subject to the application and carpet type, we suggest the TGSIs be fitted prior to the carpet being laid, using a suitable frame and backing board/s for a clean line.

**Note:** The TGSIs area is to have the frame size added to overall TGSIs area. Alternatively, (subject to the application and carpet type), the TGSIs can be installed to minimally overlap the frame / backing area to cover over the abutting carpet edge.

3. Fit a frame of correct size to suit the area required.

4. Install well fitted backing boards (marine ply) to the correct height of the frame. Firmly fix these boards to the substrate.

5. Adhere the TGSIs onto the backing boards following each prescribed procedure for either concrete or timber substrates.

**Remember.....If you are not sure ask !!!!**

#### ABOUT THIS INSTALLATION ADVICE

This information is offered as a general guide only, and specific advice should always be sought from a reputable and accredited TGSIs Installer before undertaking any installations.

This guidance does not preclude the use of other methods, materials or equipment; however the user should undertake careful evaluation and make suitable enquiries of the suitability of alternative methods, materials or equipment, before using them.

Whilst Classic Architectural Products Pty Ltd has made every effort to ensure the accuracy and effectiveness of this information, we make no representation as to the accuracy or effectiveness of the information and take no responsibility for any loss, damage or injury which may be caused as a direct or indirect result of the use of this information.

# Classic Tredfx Tactile Indicators: Individual

## Installation Guide

### Layout

It is very important that prior to installation, the project is planned and set out to achieve a satisfactory and compliant result.

Tactile Ground Surface Indicators (TGSIs) must be installed in accordance with AS1428.4 .1-2009

Generally, at stairs the TGSIs must be installed 300mm from leading nosing edge at top and bottom of the stair flight 600mm deep to the full width of the path of travel.

For ramps, TGSIs must be installed 300mm from change in plane 600mm deep to the full width of the path of travel.

Layout the TGSIs in the designated areas, using a straight edge / string line or tape to ensure the lines are straight.

**Note:** it is easier to install smaller areas at a time

### Preparation

Substrates must be virgin, uncontaminated and unsealed. TGSIs must be installed on a smooth, flat and dry surface, to ensure adhesive has maximum surface area contact with substrate. Any irregularities must be corrected before installation of the TGSIs.

**Note:** Metal TGSIs must be thoroughly cleaned with Acetone prior to installation.

Please check the product supplied is suitable to your application and complies with the Australian Standards, and read the entire instructions before starting any installation, then follow the steps.

1. Ensure all substrates are properly cured before installation i.e. concrete should be cured min 7-10 days at 25°C before commencement.

2. Thoroughly clean the surfaces from all dirt, moisture and grime, and conduct a final clean with a suitable non-residual cleaner such as Acetone. Always check in a non-obvious area to ensure the cleaner does not damage the substrate in any way.

3. Layout areas for installation using masking tape as a guide.

### Installation

#### Self-Adhesive Fixing Only – Stone, tile, masonry and timber substrates

For TGSIs without rear fixing stud

1. Place the positioning templates into position and tape the corners to hold in firmly in place.

2. Remove release paper from the back of the TGSIs and simply drop the tactile into the template.

3. Using a rubber hammer tap lightly to make sure full adhesion occurs.

4. Once the template is complete with the TGSIs, lift and remove it.

5. To continue, place the first 3 circle rows on the template over the last 3 rows of completed tactiles and continue as required.

6. Ensure the TGSIs are free of all traffic until the adhesive has achieved its full bond (allow 12-24 hrs).

### Installation

#### Mechanical Fixing – Stone, Masonry / Concrete, Timber / Metal Substrates

For TGSIs with rear fixing stud

1. Place the drilling templates into position and tape the corners to hold in firmly in place.

2. Using the drilling templates as a guide, drill the 4 corner holes (in each template) to the correct diameter into the substrate to the required depth, and using the TGSIs, firmly pin the templates into place.

#### Note re drill size:

- Metal TGSIs with a 'P' code i.e. SH10P: Drill 6mmØ diameter holes.
- Metal TGSIs with an 'N' code i.e. SH10N: Drill 8mmØ diameter holes.
- Polymer TGSIs i.e. PH06P: Drill 8mmØ diameter holes.
- A wet diamond drilling system is generally the best method for tiled/masonry substrates to ensure the substrate does not crack or shatter.

3. Once all the holes have been drilled to the correct depth, remove the templates. The holes and substrate must be thoroughly cleaned and dust free prior to installation of the TGSIs.

4. If using the Nylon stem TGSIs:

- The TGSIs can then be located into the holes, by inserting the tapered end of the stem into the hole
- Hammer firmly home using a rubber mallet

5. If using an adhesive fixed system (i.e. the 'P' stem):

- Ensure all surfaces and the holes are thoroughly clean.
- Using a suitable 2-part epoxy or polyester adhesive, dispense the properly mixed adhesive into each hole leaving a blob of adhesive on the surface.

- Apply the TGSIs with rear fixing stud into position and twist firmly into place. Check that full transfer of the adhesive to the stud and back of the TGSIs has occurred.
- Any excess adhesive that is exposed should be immediately removed.
- Ensure the TGSIs are free of all traffic until the adhesive has achieved its full cure (allow 24 hrs).

### Installation

#### Mechanical Fixing – Carpeted substrates

For TGSIs with rear fixing stud

1. For best results, discuss your particular scenario with a Classic consultant to ensure you are conversant with the methodology of installing TGSIs through carpet before proceeding.

2. Ideally in the case of dual bond or conventional carpet, before the final carpet is laid remove the underlay from TGSIs area, and replace the underlay with a ply backing board to the same thickness.

3. Lay the carpet over the backing board, including gluing it down if possible.

4. Using the drilling templates as a guide, layout the area, and mark the hole positions on the carpet.

5. Punch holes out of the carpet using a suitable wad punch.

6. Subject to the scenario, follow the procedures outlined to drill all the holes (taking care not to damage the carpet), and then install the TGSIs.

7. The TGSIs must be firm and properly bedded into the carpet. Individual packers may also be required underneath each TGSIs to raise the height of them to suit the carpet thickness.

**Note:** Where TGSIs are fitted over carpet, it is very important that they are very securely fixed down, as carpet may compress over time loosening the fixing.

**Remember.....If you are not sure ask !!!!**

#### ABOUT THIS INSTALLATION ADVICE

This information is offered as a general guide only, and specific advice should always be sought from a reputable and accredited TGSIs Installer before undertaking any installations.

This guidance does not preclude the use of other methods, materials or equipment; however the user should undertake careful evaluation and make suitable enquiries of the suitability of alternative methods, materials or equipment, before using them.

Whilst Classic Architectural Products Pty Ltd has made every effort to ensure the accuracy and effectiveness of this information, we make no representation as to the accuracy or effectiveness of the information and take no responsibility for any loss, damage or injury which may be caused as a direct or indirect result of the use of this information.

# Classic Skatestop Skate Deterrents

## Installation Guide

**NOTE:** Please check the product supplied and read the entire instructions before starting any installation, then follow the steps.

### Installation

#### DISC

Layout Classic Skatestop positions in accordance with layout plan/architects details. Classic Architectural Group can supply standard layout guides for your reference on request.

1. We suggest 500 – 700mm nominal spacings, with 150 – 200mm from ends to achieve a satisfactory level of deterrence. Nominal distance from substrate edge is 40mm.
2. Drill holes in the substrate on the pre-marked positions. Typically, this can either be done using a rotary hammer drill for concrete type substrates, or a diamond coring drill for brittle substrates such as tiles, granite and marble.
3. The Classic Skatestop Disc hole needs to be min. 12mmø x 25mm depth. Take sufficient care to ensure the substrate edge does not 'blow out'.
4. Ensure the holes are tidy, straight and free of debris, dust and loose material.
5. We strongly suggest a 'dry-run' to check fit and alignment etc prior to final installation.
6. Ensure ALL surfaces are clean and dry.
7. Mix Proprietary Brand fast curing 2-Part epoxy adhesive correctly and place into the prepared hole. Insert Classic Skatestop Disc into the hole using a twisting motion to help spread adhesive.
8. Sufficient adhesive and correct bonding is of major importance to ensure Classic Skatestop becomes an integral part of the substrate. If there is surplus adhesive, it should be carefully removed, taking care not to damage or mark the surfaces.

### Installation

#### EDGE & MAX

Layout Classic Skatestop positions in accordance with layout plan/architects details. Classic Architectural Group can supply standard layout guides for your reference on request.

1. We suggest 600 - 900mm nominal spacings (not more than 1050mm) with 200-400mm from ends, to achieve a satisfactory level of deterrence.
2. Prepare the rebates / grooves in the substrate on the pre-marked positions to suit the Classic Skatestop. Typically, this can either be a diamond saw-cut groove, a pre-cast groove, or sufficient gaps left between paving stones. The rebate needs to be 38mm depth x 7mm wide x length to suit.
3. Ensure cuts/rebates are tidy, straight and free of debris, dust and loose material.
4. We strongly suggest a 'dry-run' to check fit and alignment etc prior to final installation.
5. Ensure ALL surfaces are clean and dry.
6. Mix Proprietary Brand fast curing 2-Part epoxy adhesive correctly, and place into the prepared rebate, especially into the areas of the integral Classic Skatestop anchor points. Insert Classic Skatestop into the rebate ensuring a complete bond.
7. Sufficient adhesive and correct bonding is of major importance to ensure Classic Skatestop becomes an integral part of the substrate. If there is surplus adhesive, it should be carefully removed, taking care not to damage or mark the surfaces.
8. Once installed, the joint between the Classic Skatestop and the substrate may be either caulked or grouted with a matching colour, although generally this is only necessary for aesthetic purposes.

# Classic Integra Vanttt, Verse and Link Entrance Matting

## Care Guide

Regular and thorough maintenance of your Entrance Matting is essential to ensure optimum performance. It will help keep the Classic Integra entrance matting system active and help to effectively halt the dirt and moisture carried inside, and in turn maintaining the life and safety of your floors.

### Do

#### Daily

It is essential to remove dry soiling at least once a day. The most effective method is to use a powerful vacuum cleaner that incorporates a mechanically driven rotating brush attachment. Standard back-pack type suction only vacuum cleaners are not sufficient.

Vacuum in the direction of the profiles (not perpendicular to the direction of the profiles).

- Use a stiff brush to loosen and remove dry particles and fine soiling from the surface of the product (Fig 2).
- Use a vacuum i.e. a rotating brush head unit to collect /remove loose soiling, ensuring that the vacuum head moves along the rib length to maximize soil removal. Make sure that the rotating brush vacuum head has sufficient depth to properly clean the base of the aluminium scraper bars to fully remove soiling.
- Dry spills, can be brushed into a receptacle or vacuumed to remove.
- Small wet spills, can be soaked up as much as possible using a clean cloth or other absorbent material.
- Large wet spills, should be quickly cleaned up using a wet/dry pick-up vacuum or a hot water extraction cleaning machine to remove dirt.
- Chewing gum must be removed as soon as it appears, especially before it becomes hardened and compacted into the matting surface reducing appearance and performance. Proprietary gum removal systems such as freezing sprays or gels are readily available to assist removal. The matting components are able to withstand regular gum removal without affecting performance or structural integrity

#### Weekly/Monthly

- The matting should be carefully rolled back, section by section, and the base of the matwell thoroughly swept/vacuumed (Fig 4.).
- Any debris caught in the mat should be removed, and then the matting rolled back into position.
- Take care not to drag the matting - the Classic Integra Vanttt and Link is designed to simply roll up and unroll again. Dragging the matting could cause damage.

- Closed construction, non-rollable matting such as Classic Integra Verse should follow the daily routine, but in addition wiping the aluminium channels with a mild detergent to help free any soiling.

#### Periodically

Periodically, a more thorough cleaning of the matting in place can be conducted. Dry extraction or solution brush extraction may be used, but the use of strong cleaning chemicals should be avoided. Before beginning the extraction process, use a stiff bristle broom to loosen and remove heavy dirt deposits and fine soiling from the surface of the product (Fig 2), and then use a vacuum to collect and remove loose soiling. It is especially important for aluminium ribbed matting to scrub along the direction of the ribs.

**NOTE:** It is important to always ensure surface moisture is extracted from the products' surface to avoid premature soiling.

#### Full Remove and Clean

Periodically carefully remove the matting and thoroughly clean / vacuum out the mat well and frames (Fig 1). This also allows for inspection of the mat well to check on the condition, as well as facilitating rotation of modules if appropriate.

- Vacuum the mat surface to remove soil prior to removal.
- Clean out soil filtrated to the base of the matwell and frame (Fig 4.). Depending on the degree of soiling, clean the matting using the above methods or in excessive soil situations, hot water extraction or jet wash methods may be more appropriate (Fig 3.). Temperatures must not exceed 60°C.
- It is important that the matting and the mat wells are fully dry before reinstating (Fig 5.).
- Re-install the mats to the correct locations, following the approved guide. Do not force mat sections into place.

#### Maintain the Mat Well

Periodically check and clean the mat well to ensure it is perfectly smooth and level (Fig 4.). There should be no residue or debris remaining under the mats. This will avoid warping of the matting because of an uneven substrate and prevent long term problems.

### Specialist Advice

Contact Classic Architectural Group for a specialist mat and mat well inspection and report to ensure the optimum performance of your entrance matting. As with all matting, when subject to heavy wheeled traffic (i.e. scissor lifts / pallet trucks etc) it should be suitably protected with plywood boards.

### Don't

- Use standard type back-pack suction only vacuum cleaners for cleaning.
- Steam clean or commercially dry clean.
- Use cleaning chemicals containing chlorinated hydrocarbons and/or bleaching/oxidizing agents.
- Clean using commercial 'ride-on' style floor cleaners / scrubbers with circular rotating heads. These only act to clean the dirt off their cleaning pads from the surrounding floors onto the matting.

### PLEASE NOTE

Careful and regular maintenance is necessary to ensure applicable warranties are not voided.

This information is based on our experience to date and the results of careful testing. Varying site conditions and methods of use may influence the practical application.

This information is offered as a general guide only and specific advice should always be sought from a reputable cleaning professional before undertaking any cleaning or maintenance.

This guidance does not preclude the use of other methods, materials or equipment; however the user should undertake careful evaluation and make suitable enquiries of the suitability of alternative methods, materials or equipment, before using them.

Whilst Classic Architectural Group has made every effort to ensure the accuracy and effectiveness of this information, we make no representation as to the accuracy or effectiveness of the information and takes no responsibility for any loss, damage or injury which may be caused as a direct or indirect result of the use of this information.

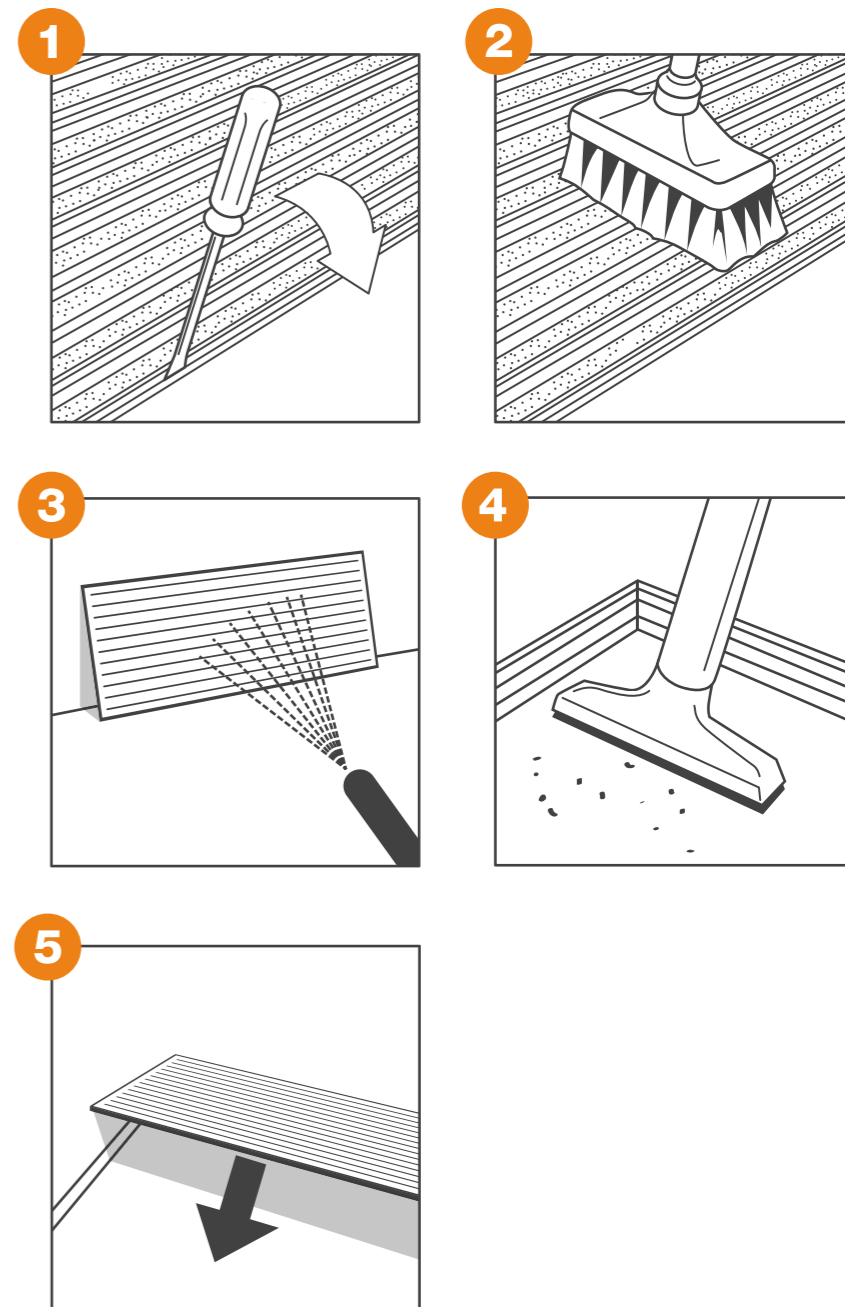

# Classic Integra Carpet Style Matting Entrance Matting

## Care Guide

Regular and thorough maintenance of your Entrance Matting is essential to ensure optimum performance. It will help keep the Classic Integra entrance matting system active and help to effectively halt the dirt and moisture carried inside, and in turn maintaining the life and safety of your floors.

### Do

#### Daily

It is essential to remove dry soiling at least once a day. The most effective method is to use a powerful vacuum cleaner that incorporates a mechanically driven rotating brush attachment. Standard back-pack type suction only vacuum cleaners are not sufficient.

- Dry spills, can be brushed into a receptacle or vacuumed to remove.
- Small wet spills, can be soaked up as much as possible using a clean cloth or other absorbent material.
- Large wet spills, should be quickly cleaned up using a wet/dry pick-up vacuum or a hot water extraction cleaning machine to remove dirt.
- Chewing gum must be removed as soon as it appears, especially before it becomes hardened and compacted into the matting surface reducing appearance and performance. Proprietary gum removal systems such as freezing sprays or gels are readily available to assist removal. The matting components are able to withstand regular gum removal without affecting performance or structural integrity.

#### Weekly/Monthly

- The matting should be carefully rolled back, section by section, and the base of the matwell thoroughly swept/vacuumed (Fig 4.).
- Any debris caught in the mat should be removed, and then the matting rolled back into position.
- Take care not to drag the matting - it is designed to simply roll up and unroll again. Dragging the matting could cause damage.

### Don't

- Machine wash.
- Steam clean or commercially dry clean.
- Use harsh cleaning chemicals.
- Use cleaning chemicals containing chlorinated hydrocarbons and/or bleaching/oxidizing agents.

Clean using commercial 'ride-on' style floor cleaners / scrubbers with circular rotating heads. These only act to clean the dirt off their cleaning pads from the surrounding floors onto the matting.

#### PLEASE NOTE

Careful and regular maintenance is necessary to ensure applicable warranties are not voided.

This information is based on our experience to date and the results of careful testing. Varying site conditions and methods of use may influence the practical application.

This information is offered as a general guide only and specific advice should always be sought from a reputable cleaning professional before undertaking any cleaning or maintenance.

This guidance does not preclude the use of other methods, materials or equipment; however the user should undertake careful evaluation and make suitable enquiries of the suitability of alternative methods, materials or equipment, before using them.

Whilst Classic Architectural Group has made every effort to ensure the accuracy and effectiveness of this information, we make no representation as to the accuracy or effectiveness of the information and takes no responsibility for any loss, damage or injury which may be caused as a direct or indirect result of the use of this information.

# Classic Tredfx Stair Nosing

## Care Guide

Regular maintenance of your Stair Nosings will help keep the Tredfx system active – helping to enhance your safety; but just as importantly the safety, dignity and independence of persons who are blind or vision-impaired with their orientation in the built environment.

### Do

#### Daily

- Sweep thoroughly, preferably with a soft bristle brush to remove grit, sand and dust. Loose dirt can also be rinsed off with clear water.

#### Monthly

To increase the life of your Tredfx products, we suggest that this cleaning /maintenance procedure be carried out every 1-2 months, or as otherwise needed.

- Sweep with a stiff bristle broom to loosen heavy dirt deposits.
- Wash with clean water where in external applications.
- Mix a PH neutral based detergent with warm to hot water in a bucket.
- Using a stiff bristled deck scrubber, dip into bucket of detergent, and then vigorously scrub the surface of the nosings to remove any dirt build up.
- Rinse off with clean water and then rescrub the nosings ensuring no detergent residue remains.

**NOTE:** If dirt, grime and surface stains containing corrosive substances are left on the surface, corrosion may occur.

#### Periodically

- Periodically inspect the condition of all the nosings to ensure that they are still securely fixed to the substrate.
- Should any be loose, rectify them immediately using the appropriate tools and following the approved guide.
- If inserts are damaged or unduly worn, they can be recycled and replaced with minimal cost implications. Refer to Classic Architectural Group for further assistance.

### Don't

- Steam clean or commercially dry clean when in carpeted areas.
- Use harsh cleaning chemicals especially those that contain chlorides or abrasives.
- Clean using a wire brush or high pressure water blasters.

#### ABOUT THIS CLEANING AND MAINTENANCE ADVICE

Careful and regular maintenance is necessary to ensure applicable warranties are not voided.

This information is based on our experience to date and the results of careful testing. Varying site conditions and methods of use may influence the practical application.

This information is offered as a general guide only and specific advice should always be sought from a reputable cleaning professional before undertaking any cleaning or maintenance.

This guidance does not preclude the use of other methods, materials or equipment; however the user should undertake careful evaluation and make suitable enquiries of the suitability of alternative methods, materials or equipment, before using them.

Whilst Classic Architectural Group has made every effort to ensure the accuracy and effectiveness of this information, we make no representation as to the accuracy or effectiveness of the information and takes no responsibility for any loss, damage or injury which may be caused as a direct or indirect result of the use of this information.



## Care Guide

Regular maintenance of your TGSIs will help keep the Tredfx TGSIs system active – helping to enhance the safety, dignity and independence of persons who are blind or vision-impaired with their orientation in the built environment.

### Do

#### Daily

- Sweep thoroughly, preferably with a soft bristle brush to remove grit, sand and dust. Loose dirt can also be rinsed off with clear water.

#### Monthly

To increase the life of your Tredfx TGSIs products, we suggest that this cleaning / maintenance procedure be carried out every 1-2 months, or as otherwise needed.

- Sweep with a stiff bristle broom to loosen heavy dirt deposits.
- Wash with clean water where in external applications.
- Mix a PH Neutral Based detergent with warm to hot water in a bucket.
- Using a stiff bristled deck scrubber, dip into bucket of detergent, and then vigorously scrub the surface of the TGSIs to remove any dirt build up.
- Rinse off with clean water and then rescrub the nosings ensuring NO detergent residue remains.

**NOTE:** If dirt, grime and surface stains containing corrosive substances are left on the surface, especially stainless steel TGSIs, corrosion may occur.

- A mild degreaser can be used on stainless steel TGSIs to remove oil stains. If the surface has been neglected or there are stubborn deposits, a mild, non-acidic, non-scratching, abrasive powder that does not contain chlorides or a suitable proprietary cleaning product can be used.

#### Periodically

- Periodically inspect the condition of all the TGSIs to ensure that they are still securely fixed to the substrate.
- Should any be loose or missing, rectify them immediately using the appropriate tools and following the approved guide.

### Don't

- Steam clean or commercially dry clean when in carpeted areas.
- Use harsh cleaning chemicals especially those that contain chlorides or abrasives.
- Clean using commercial 'ride-on' style floor scrubbers, or using a wire brush.

#### ABOUT THIS CLEANING AND MAINTENANCE ADVICE

Careful and regular maintenance is necessary to ensure applicable warranties are not voided.

This information is based on our experience to date and the results of careful testing. Varying site conditions and methods of use may influence the practical application.

This information is offered as a general guide only and specific advice should always be sought from a reputable cleaning professional before undertaking any cleaning or maintenance.

This guidance does not preclude the use of other methods, materials or equipment; the user should undertake careful evaluation and make suitable enquiries of the suitability of alternative methods, materials or equipment, before using them.

Whilst Classic Architectural Group has made every effort to ensure the accuracy and effectiveness of this information, we make no representation as to the accuracy or effectiveness of the information and takes no responsibility for any loss, damage or injury which may be caused as a direct or indirect result of the use of this information.

## Care Guide

Classic Skatestop is manufactured from Marine grade Stainless Steel, for a high level of vandal resistance with minimal maintenance. However, we do recommend regular maintenance to help keep the Classic Skatestop system active.

### Do

#### Monthly

To increase the life of your Classic Skatestop products, we suggest that this cleaning / maintenance procedure be carried out every 1-2 months, or as otherwise needed.

- Sweep with a stiff bristle broom to loosen heavy dirt deposits.
- Wash with clean water where in external applications.
- Mix a PH Neutral Based detergent with warm to hot water in a bucket.
- Using a stiff bristled deck scrubber, dip into bucket of detergent, and then vigorously clean.
- Rinse off with clean water and then rescrub the nosings ensuring no detergent residue remains.

**NOTE:** If dirt, grime and surface stains containing corrosive substances are left on the surface, corrosion may occur.

- Should any staining of the stainless steel occur, it is likely to be surface discolouration only. This is not detrimental to structure of the product and can be polished off.

#### Monthly

- Periodically inspect the Classic Skatestop installation to ensure that they are still securely fixed to the substrate.
- Should any be loose or missing, rectify them immediately to prevent damage from the most determined of vandals, using the appropriate tools and following the approved guide.

**NOTE:** All Classic Skatestop products are clearly marked for warranty purposes. Removal of such markings voids all available product warranties.

### Don't

- Steam clean or commercially dry clean when in carpeted areas.
- Use harsh cleaning chemicals especially those that contain chlorides or abrasives.
- Clean using commercial 'ride-on' style floor scrubbers, or using a wire brush.

#### ABOUT THIS CLEANING AND MAINTENANCE ADVICE

Careful and regular maintenance is necessary to ensure applicable warranties are not voided.

This information is based on our experience to date and the results of careful testing. Varying site conditions and methods of use may influence the practical application.

This information is offered as a general guide only and specific advice should always be sought from a reputable cleaning professional before undertaking any cleaning or maintenance.

This guidance does not preclude the use of other methods, materials or equipment; the user should undertake careful evaluation and make suitable enquiries of the suitability of alternative method, materials or equipment, before using them.

Whilst Classic Architectural Group has made every effort to ensure the accuracy and effectiveness of this information, we make no representation as to the accuracy or effectiveness of the information and takes no responsibility for any loss, damage or injury which may be caused as a direct or indirect result of the use of this information.





1300 244 377

[info@classic-arch.com](mailto:info@classic-arch.com)

[www.classic-arch.com](http://www.classic-arch.com)

Melbourne • Sydney • Brisbane  
Adelaide • Perth • Auckland

